

American Security

Gun Safes



Residential Safes



Luxury Fire & Burglary Safes

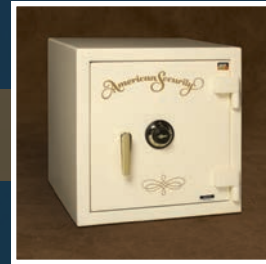

Depository & Cash Management



U.L. Listed High Security



Commercial Safes



Locks



**Product
Catalog
2012**

TABLE OF CONTENTS



American Security Products Company has been dedicated to manufacturing high quality, high security safes since 1946. We offer an extensive product line of over 400 standard models of burglary and fire resistant safes in every insurance classification from "B" rate to Underwriter's Laboratories TL-15 and TL-30.

AMSEC is the largest and most respected safe manufacturer in the industry because:

- Our dedicated customer service representatives care about you.
- Fully staffed service department networked with thousands of factory trained technicians.
- Our quality control department assures that the products we build are the finest in the industry.
- State-of-the-art computer controlled manufacturing equipment helps us meet demanding deadlines and keeps us on the leading edge of technology.
- We are located in a major West Coast distribution point with direct access to all major domestic and international freight services.
- We specialize in developing custom safes to meet specific cash handling requirements for banks, restaurants, supermarkets, convenience stores and many other industries.
- Our engineering and design department is fully staffed and features the most advanced CAD system for rapid creation of sales drawings, design modifications and precise manufacturing blue prints.

For superior asset protection there is only one name you can trust for quality, service and reliability... **AMSEC.**

AMSEC reserves the right to incorporate any improvements and alter any specifications without prior notice. AMSEC reserves the right to update products as necessary, AMSEC is not responsible for typographical errors.

SQUARE DOOR FLOOR SAFES	4
<i>BRUTE, SUPER BRUTE AND MINI BRUTE SERIES</i>	4
FLOOR SAFES	6
<i>STAR® ROUND LIFT-OUT DOOR</i>	6
<i>STAR® RECTANGULAR BODY, ROUND LIFT-OUT DOOR</i>	7
<i>MAJOR® ROUND LIFT-OUT DOOR</i>	7
WALL SAFES	8
UNDERCOUNTER SAFES	9
CASH MANAGEMENT SAFES	
<i>NEW! RETAIL MONEY MANAGER SAFE</i>	10
<i>BSW SERIES - THE SAFEWIZARD®</i>	11
DEPOSITORY SAFES	
<i>BWB SERIES - WIDE BODY CASH CONTROL</i>	12
<i>DS SERIES - "B" RATE ROTARY AND FRONT LOADING</i>	13
<i>MONEY MANAGER</i>	14
"B" RATE SECURITY SAFES	
<i>BWB SERIES, US2015 AND MS1414</i>	15
"B" AND "C" RATE SECURITY CHESTS	
<i>BLB AND BLC SERIES</i>	16
UL SERIES	
<i>U.L. LISTED 2-HOUR FIRE AND IMPACT SAFES</i>	17
BF® SERIES	
<i>U.L. LISTED FIRE RATED BURGLARY SAFES</i>	18
COMMERCIAL SECURITY SAFES	
<i>CSC SERIES COMPOSITE SAFES</i>	19
IMPORTED U.L. LISTED 1-HR FIRE SAFES	20
ELECTRONIC SECURITY SAFES	21
CASH BOX AND KEY CABINET	21
ELECTRONIC SAFES	22
GUN SAFES	
<i>HS SERIES - HIGH SECURITY</i>	23
<i>THE BF® SERIES GUN SAFES</i>	24
<i>SF SERIES - SIXTY MINUTE FIRE</i>	25
<i>TF SERIES - THIRTY MINUTE FIRE</i>	26
<i>GUN SAFE ACCESSORIES AND OPTIONS</i>	27
NEW! DEFENSE VAULT	28
EXECUTIVE SAFE	29
VAULT DOOR	29
HOME SECURITY	
<i>AM SERIES HOME SECURITY SAFES</i>	30
<i>HANDGUN SECURITY</i>	30
DXE / DXF AND CDXE / CDXF U.L. LISTED	
<i>TL-15 & TL-30 MONEY CHESTS</i>	31
ACF TL-30 SERIES	32
<i>U.L. LISTED FIRE RATED MONEY CHEST</i>	32
<i>U.L. LISTED FIRE RATED DEPOSITORY SAFE</i>	33
<i>AMVAULTx6 TL-30x6 HIGH SECURITY SAFE</i>	33
AMVAULT TL-30 AND TL-15	
<i>FIRE RATED COMPOSITE SAFES</i>	34
<i>SAFE SPECIFICATIONS</i>	35
MECHANICAL LOCKS AND KEY LOCKS	36
OPTIONAL EXTRAS	37
TELLER LOCKERS	38
CUSTOM SAFES	38
ELECTRONIC LOCKS	
<i>ELECTRONIC LOCK COMPARISON CHART</i>	39
<i>AMSEC SAFEWIZARD®</i>	40
<i>AMSEC ESL20x2</i>	40
<i>AMSEC ESL-XL SERIES</i>	41
<i>AMSEC BIOMETRIC ELECTRONIC LOCK</i>	42
<i>SARGENT AND GREENLEAF COMPTRONIC™</i>	42
<i>KABA-MAS AUDITCON® 2</i>	42
<i>LAGARD ELECTRONIC SAFE LOCKS</i>	43
MATERIALS HANDLING EQUIPMENT	44
STORAGE OPTIONS	45
MERCHANDISING / DISPLAYS	46
INDEX BY MODEL NUMBER	47

A GUIDE TO SAFE USAGE

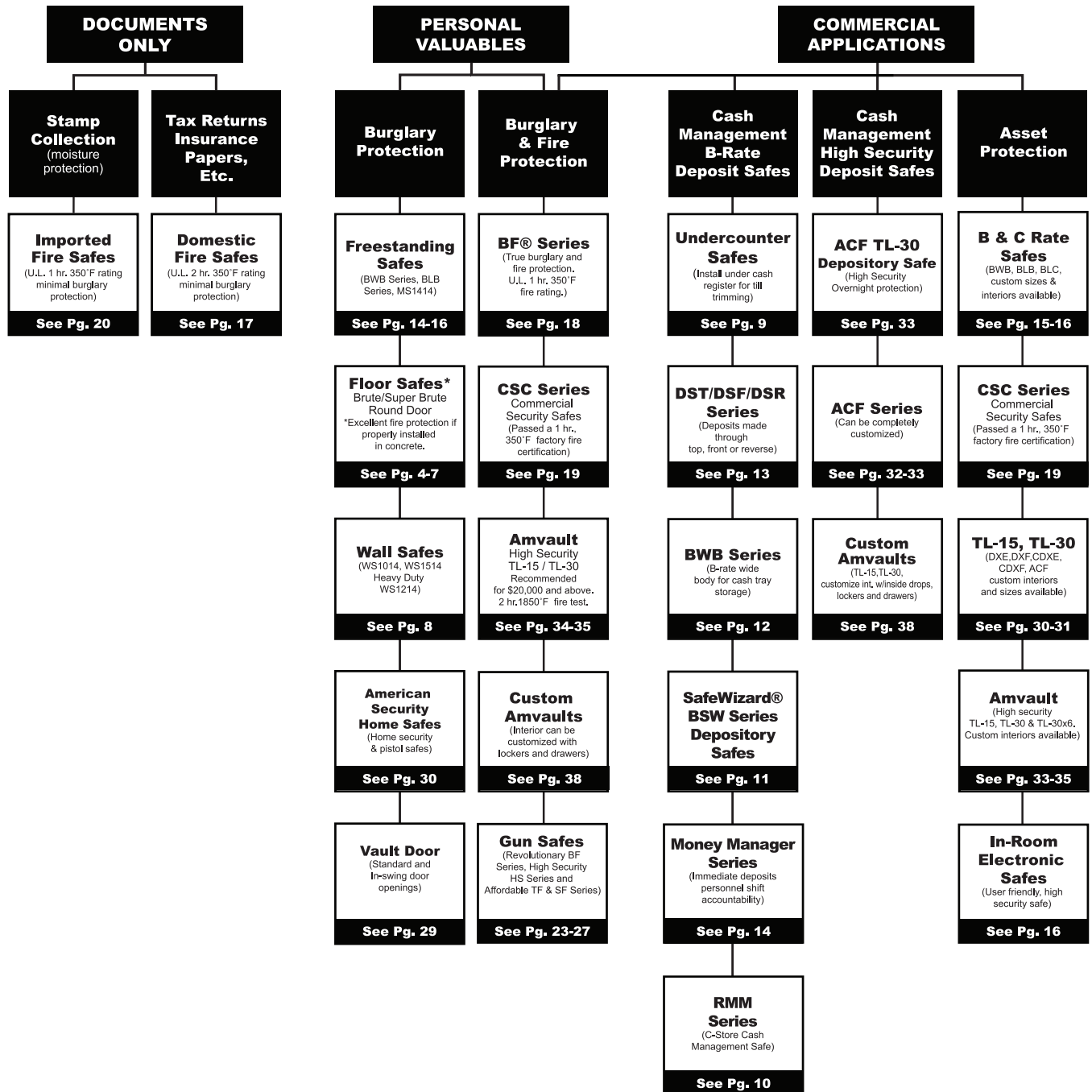

REQUIRED FED EX / UPS PACKAGING

Additional packaging is required for all safes shipping via FedEx or UPS to protect the safe from transit damage. This excludes products already packaged for FedEx or UPS shipment.*

Maximum weight for FedEx or UPS is 150 lbs.

AMSEC will not be held liable for damages if this packaging is not requested at the time of order.

Order Part #4505400

Net up charge \$8.00 per package.

*PB2 / WS1814

BRUTE, SUPER BRUTE AND MINI BRUTE SERIES



All BRUTE SERIES safes are designed to provide secure storage for documents, jewelry, precious metals and miscellaneous valuables at an economical price. When properly installed in a concrete floor, BRUTE SERIES safes provide excellent fire and burglary protection. BRUTE floor safes meet and exceed the requirements of the Insurance Offices Manual of Burglary Insurance. You may also add many options to customize your safe such as: A drop slot in the door, depository chute, digital keypad lock and keylocking dial to name a few. BRUTE SERIES safes may be installed in the floor, wall, cladding or within a larger safe.



**SUPER BRUTE
MODEL 2200**



**TOP VIEW
OF B1500
SUPER BRUTE**

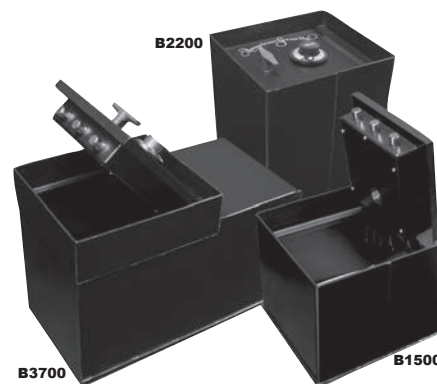

B3700

B1500

SUPER BRUTE & BRUTE

STANDARD FEATURES:

- Black textured body and door.
- Large brass plated dial and black matte finish dial ring with matching handle.
- End user can get combination changes by just bringing the door to a locksmith.
- Attractive design offers strong reliable welds to protect against burglary attacks and reduce possible leakage.
- U.L. listed Group II key changeable lock, with relock and 1 million possible combinations.
- An additional spring-loaded reloading device, activated by a punching attack.
- Lock and relocks are protected by a large carburized hardplate.
- A handle activated locking mechanism consisting of three 1" diameter locking bolts. Each one is drive resistant, chromed steel with a long throw.
- One piece heavy duty dead bar behind hinge prevents removal of door even if hinges are removed during a forced entry attempt.

- Door is designed to fit full body size, which greatly reduces any possible pry points.
- Doors are interchangeable within product group.

BODY:

- Oversize floor plate ensures strong installation in concrete.
- Flush cover plate.
- Solid steel hinge mechanism using $\frac{3}{8}$ " diameter steel hinge pins and internal mounting bolts.

SUPER BRUTE SERIES

ADDITIONAL FEATURES:

- The **SUPER BRUTE's** new door jamb design is manufactured with state-of-the-art equipment, with built-in devices offering the ultimate protection against sledgehammer attack.
- "B+" rate door: $\frac{3}{4}$ " **solid steel plate door** is standard.
- Doors are removable and interchangeable.
- A large, convenient $10\frac{3}{4}$ " x $11\frac{1}{8}$ " door opening for bulky items.
- One sliding shelf with double wide model (B3700). Two sliding shelves with triple wide models (B5800).
- Attractive carpeted floor in every unit.

For Slotted Door see Page 37

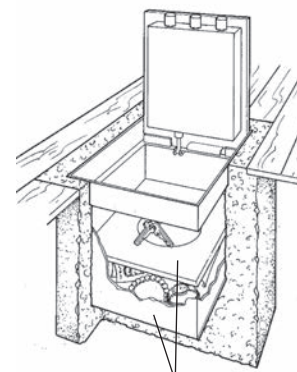

DOUBLE COMPARTMENT

Super Brute Floor Safes

Lifetime Replacement Warranty:

If your AMSEC Super Brute floor safe is subject of a sledgehammer or pry attack and is forcibly entered, AMSEC will replace or repair the safe (our option) with a current production model of comparable value - free of charge. The damaged safe must be returned freight prepaid to the factory within 30 days of the loss, accompanied by a properly filled police report. This warranty does not apply to damage or loss resulting from accident, alteration, unauthorized entry or improper installation. AMSEC's limited warranty policy and procedures applies to any extended product warranties.



BRUTE, SUPER BRUTE AND MINI BRUTE SERIES

SQUARE DOOR FLOOR SAFES



BRUTE RECTANGULAR BODY, WIDE DOOR

ADDITIONAL FEATURES:

- A large, convenient 11 $\frac{3}{4}$ " x 16" door opening, for large bulky items or cash tray storage.
- B-rate door of $\frac{1}{2}$ " solid steel plate.

MINI BRUTE

DOOR:

- Black textured body and door.
- Large brass plated dial and black matte finish dial ring.
- $\frac{1}{2}$ " A36 solid steel plate. New steel guards protect lock and relock from accidental damage.
- U.L. listed Group II lock with relock. An additional relocking device, activated by punching attack.
- Heavy duty dead bar prevents removal of door during forced entry attempt.

- Convenient, reversible lift-out door with a heavy duty handle.
- Optional baffled drop slot in door

BODY:

- 8" square tubular "B" Rate construction.
- Universal jamb design allows the door to be positioned in all four directions.
- A flush cover plate for total concealment under a carpet.

SuperBrute "B" Rate Rectangular Hinged Door Floor Safes

Model	Inside Dimension H x W x D	Outside Dimension H x W x D	Clear Door H x W x D	Cu. In. Capacity	Wt.
B1500*	12 $\frac{1}{4}$ x 13 $\frac{1}{4}$ x 8 $\frac{3}{4}$	12 $\frac{3}{4}$ x 14 $\frac{1}{8}$ x 11 $\frac{3}{4}$	10 $\frac{3}{4}$ x 11 $\frac{1}{8}$	1377	102
B2200*	12 $\frac{1}{4}$ x 13 $\frac{1}{4}$ x 14	12 $\frac{3}{4}$ x 14 $\frac{1}{8}$ x 17 $\frac{1}{2}$	10 $\frac{3}{4}$ x 11 $\frac{1}{8}$	2203	118
B2900*	12 $\frac{1}{4}$ x 13 $\frac{1}{4}$ x 18 $\frac{1}{4}$	12 $\frac{3}{4}$ x 14 $\frac{1}{8}$ x 21 $\frac{3}{8}$	10 $\frac{3}{4}$ x 11 $\frac{1}{8}$	2872	134
B3800*	12 $\frac{1}{4}$ x 18 x 17	12 $\frac{3}{4}$ x 18 $\frac{3}{4}$ x 21 $\frac{3}{8}$	10 $\frac{3}{4}$ x 11 $\frac{1}{8}$	3864	136
B3700*	12 $\frac{1}{4}$ x 23 x 14	12 $\frac{3}{4}$ x 24 x 17 $\frac{1}{2}$	10 $\frac{3}{4}$ x 11 $\frac{1}{8}$	3785	145
B5800*	12 $\frac{1}{4}$ x 35 x 14	12 $\frac{3}{4}$ x 36 x 16 $\frac{3}{4}$	10 $\frac{3}{4}$ x 11 $\frac{1}{8}$	5758	185

*Constructed of 3/4" door and B-Rate body. Slotted outer door not recommended for use on B1500.

Brute Wide Door "B" Rate Rectangular Hinged Door Floor Safes

Model	Inside Dimension H x W x D	Outside Dimension H x W x D	Clear Door H x W x D	Cu. In. Capacity	Wt.
B1806	12 $\frac{1}{4}$ x 18 $\frac{1}{2}$ x 6	13 $\frac{1}{4}$ x 19 $\frac{1}{2}$ x 9	11 $\frac{3}{4}$ x 16	1360	102
B1810	12 $\frac{1}{3}$ x 18 $\frac{1}{2}$ x 10	13 $\frac{1}{4}$ x 19 $\frac{1}{2}$ x 13	11 $\frac{3}{4}$ x 16	2281	116
B1816	12 $\frac{1}{4}$ x 18 $\frac{1}{2}$ x 16	13 $\frac{1}{4}$ x 19 $\frac{1}{2}$ x 19	11 $\frac{3}{4}$ x 16	3626	142
B1816D*	12 $\frac{1}{4}$ x 18 $\frac{1}{2}$ x 5 $\frac{1}{8}$ (top) 12 $\frac{1}{4}$ x 18 $\frac{1}{2}$ x 10 (btm)	13 $\frac{1}{4}$ x 19 $\frac{1}{2}$ x 19	11 $\frac{3}{4}$ x 16 (top) 6 $\frac{3}{8}$ DIA (btm)	1303 (top) 2266 (btm)	152

*Double Compartment - Slotted inner door. Slotted door not recommended for use on B1806.

"B" Rate Square Body / Lift-Out Door Floor Safes

Model	Inside Dimension H x W x D	Outside Dimension H x W x D	Clear Door H x W x D	Cu. In. Capacity	Wt.
B400*	7 $\frac{5}{8}$ x 7 $\frac{5}{8}$ x 6 $\frac{3}{4}$	8 $\frac{1}{2}$ x 8 $\frac{1}{2}$ x 10 $\frac{1}{8}$	6 $\frac{5}{8}$ x 6 $\frac{5}{8}$	393	32
B700*	7 $\frac{5}{8}$ x 7 $\frac{5}{8}$ x 11 $\frac{3}{4}$	8 $\frac{1}{2}$ x 8 $\frac{1}{2}$ x 15 $\frac{1}{8}$	6 $\frac{5}{8}$ x 6 $\frac{5}{8}$	683	42

Slotted door not recommended for use on B400. *Optional UPS packaging available. See inside front cover for information.

STAR® ROUND LIFT-OUT DOOR



FLOOR SAFES are engineered with advanced security features. STAR Tube safes have been the standard for gas stations, fast food, small retail establishments and home owners for over 50 years.

Low cost, combined with the various body styles and optional doors will fit almost any cash handling system. When properly installed in concrete, STAR® FLOOR SAFES provide maximum fire and burglary protection. Now, with the water-resistant dust cover, you get protection from water as well.

“C” RATE LIFT-OUT DOOR FEATURES:

- Manipulation resistant, unitized U.L. Group II key changeable lock protected by a revolving carburized hardplate.
- Removable dial and drive/drill resistant spindle preventing damage from burglary attack and additional protection from hold-up.
- Door, 7-1/4" clear opening, is 1-3/4" solid steel.
- Door is securely locked by three bolts each requiring over 25,000 pounds to shear.
- Each locking bolt has its own hardened steel positive relocking bolt.
- Body — Heavy “B” rate construction.

OTHER FEATURES:

- Water resistant, high impact molded dust cover with rubber “O”-ring seal does not rattle or slide like most covers.
- STAR’s double compartment models provide the commercial user with the most effective cash handling system available. Hold-up as well as burglary protection is greatly enhanced by use of this type of safe.
- Available with dual key inner compartment. Manager holds one key, the armored car driver, or employee holds the second.



STAR® “C” RATE TUBULAR BODY SAFES



CUTAWAY VIEW OF STAR® DOUBLE COMPARTMENT

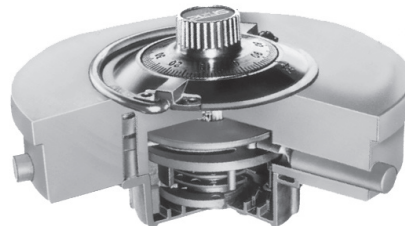

CUTAWAY VIEW “C” RATE LIFT-OUT DOOR



COMBINATION DOOR WITH DROP SLOT



WATER RESISTANT DUST COVER



KEYLOCK DOOR

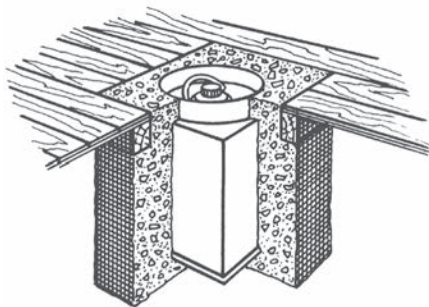

When properly installed in concrete, STAR® Floor Safes provide excellent fire and burglary protection. Now, with the water resistant dust cover, you get protection from water as well.

Model	Inside Dimension H x W x D	Outside Dimension H x W x D	Clear Door H x W x D	Cu. In.	Wt.
C3	8 1/4 DIA x 5 1/4	8 3/4 DIA x 9	7 1/4 DIA	280	40
C5	8 1/4 DIA x 10	8 3/4 DIA x 13 1/2	7 1/4 DIA	510	46
C7	8 1/4 DIA x 16	8 3/4 DIA x 19	7 1/4 DIA	785	55
CD5*	8 1/4 DIA x 4 1/4 (top) 8 1/4 DIA x 4 1/2 (btm)	8 3/4 DIA x 13 1/2	7 1/4 DIA (top) 6 3/8 DIA (btm)	225 (top) 240 (btm)	54
CD7*	8 1/4 DIA x 5 1/4 (top) 8 1/4 DIA x 9 (btm)	8 3/4 DIA x 19	7 1/4 DIA (top) 6 3/8 DIA (btm)	175 (top) 480 (btm)	66

*Double Compartment-Slotted Inner Door



STAR® RECTANGULAR BODY, ROUND LIFT-OUT DOOR

FLOOR SAFES



Rectangular Body, Round Lift-out Door
"B" RATE

FLOOR SAFES offer a large cubic inch capacity at a reasonable price. Strong, continuously welded steel bodies are offered with our standard "C" rate lift-out combination door and water-resistant dust cover.

"C" RATE LIFT-OUT FEATURES

DOOR:

- Utilizes the STAR high security "C" Rate door.

BODY:

- "B" Rate construction available in double compartment models (D) or outside drop chute (BDP).



Model	Inside Dimension H x W x D	Outside Dimension H x W x D	Clear Door H x W x D	Cu. In.	Wt.
B6	12 x 10 x 5¼	12½ x 11¼ x 9¾	7¼ DIA	630	62
B17	12 x 12½ x 10	13 x 13 x 15	7¼ DIA	1500	98
B24	12 x 12½ x 14½	13 x 13 x 19	7¼ DIA	2175	122
BD24*	12 x 12½ x 5½ (top) 12 x 12½ x 10 (btm)	13 x 13 x 20	7¼ DIA 6⅝ DIA (btm)	825 1500 (btm)	130
BDP24**	12 x 12½ x 4¼ (top) 12 x 12½ x 13¾ (btm)	13 x 13 x 22	7¼ DIA 6⅝ DIA (btm)	638 2063 (btm)	142

*Double Compartment-Slotted Inner Door. **Double Compartment - Solid Inner Door with Outside Drop Chute



MAJOR® ROUND LIFT-OUT DOOR

MAJOR® Tubular Body, Round Lift-Out DOOR FLOOR SAFES provide excellent fire and burglary protection when properly installed in concrete.

"C" RATE LIFT-OUT DOOR FEATURES

- Unitized U.L. Group II key changeable lock with randomized opening positions defends against drill attacks.
- Drive resistant dial and spindle blocks sledgehammer attacks.
- Door, 6⅝" clear opening, is 1" thick solid steel.
- Door is securely closed by three ⅝" drive resistant locking bolts.
- A positive relocking device jams locking mechanism in the event of a forced entry attempt.
- Recessed locking mechanism protected by a large carburized hardplate.
- Heavy duty "B" rate solid steel body with reinforced door jamb.
- Available in double compartment models (DD) with a key locking inner door.
- Inside slot to bottom compartment on all (DD) models.



Model	Inside Dimension H x W x D	Outside Dimension H x W x D	Clear Door H x W x D	Cu. In.	Wt.
T425	8¼ DIA x 5¾	8⅝ DIA x 8¾	6⅝ DIA	307	40
T625	8¼ DIA x 10¼	8⅝ DIA x 13¼	6⅝ DIA	545	46
T925	8¼ DIA x 15¾	8⅝ DIA x 18¾	6⅝ DIA	840	54
T625DD*	8¼ DIA x 4½ (top) 8¼ DIA x 5¼ (btm)	8⅝ DIA x 13¾	6⅝ DIA 6⅝ DIA	241 285	54
T925DD*	8¼ DIA x 7½ (top) 8¼ DIA x 7¾ (btm)	8⅝ DIA x 18¾	6⅝ DIA 6⅝ DIA	401 420	64

*Double Compartment - Solid Inner Door with Drop Chute.



CUTAWAY VIEW OF "MAJOR" DOOR



WALL SAFES

AMSEC **WALL SAFES** are designed to provide hidden protection for documents and miscellaneous valuables. Each wall safe is also designed for easy installation between 16" o/c wall studs. Pre-drilled anchor holes and a built-in flange eliminates unnecessary replastering.



WEST2114

**NEW!
WEST2114
FEATURES:**

- Heavy duty steel body, 3/16" solid steel door and flange.
- Extra spacious interior, while still offering the convenience of fitting between studs.

- New State-of-the-art DL5000 electronic lock with a large 3 3/4" touch screen LCD input display allows smooth and easy operation.
- Mode altering display changes from orange in standby mode to bright blue in the open position.
- Accepts (2) user codes and can show open door records for the past 14 entries.
- LCD touch screen display shows low-battery indicator, time, date and keypad.
- Emergency key-lock override system with two (2) keys, power override battery box, built-in spy-proof function and motion detector alert.
- Dual live bolts ensure protection against pry attacks.
- Two removable shelves.
- Cream colored, durable powder coated finish.
- Packaged for UPS shipment.



WS1014

WS1514K

WS1014 / WS1514K

FEATURES:

- U.L. listed Group II key changeable lock, with relock and 1 million possible combinations.
- Electronic lock optional, or Chicago single key camlock with 2 keys. WS1514K offered with Chicago single key camlock with 2 keys only.
- Flat dial allows flush mounted installation.
- WS1014: 3/16" thick solid steel door with dead bar.

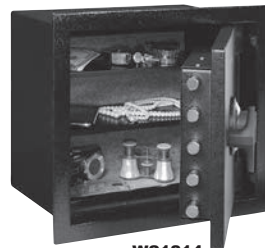

WS1214

HEAVY-DUTY WS1214

FEATURES:

- Same features as Super Brute Floor safes. Please see page 4.
- Two removable shelves. Extra deep interior.



WEST149

When fire is a concern, there is no better wall safe than the WFS149 or WEST149.

WFS149

FEATURES:

- UL Listed one hour fire rating, insuring the inside temperature never exceeded 350° F (paper chars at 450° F).
- Extra deep interior, with one (1) convenient drawer shelf.
- Combo lock with key operated side-locking mechanism incorporating two chromed locking bolts.
- Each safe is equipped with side locking boltwork mechanism incorporating 1/2" steel deadbolts.
- Impressive 1/2" thick door with attractive two-tone Sage finish.

NEW! WEST149 with DL5000 Electronic Lock

FEATURES:

- Same outstanding features of the WFS149 and comes equipped with our easy to operate and easy change DL5000 touch-screen keypad. Plus, one (1) auxiliary key lock with two (2) keys, bright blue LCD display with a low-battery indicator and a power override battery box.

Model	Inside Dimension H x W x D	Outside Dimension H x W x D	Clear Door H x W x D	Cu. In.	Wt. Lbs	Interior Shelves
WS1014**	10 x 13 3/4 x 3 1/2	12 1/4 x 15 3/4 x 4	9 5/8 x 12 3/4	481	20	1
WS1514K	15 x 14 x 3 1/2	16 1/2 x 15 1/2 x 4	14 x 13 1/4	688	24	2
WFS149*	14 x 8 1/2 x 10 5/8	19 1/8 x 13 1/2 x 15 3/4	14 x 8 1/2	1,250	106	1
WEST149*	14 x 8 1/2 x 10 1/2	19 1/8 x 13 1/2 x 15 3/4	14 x 8 1/2	1,250	106	1
WS1214	12 x 13 1/2 x 5 1/2	12 5/8 x 14 1/8 x 10	10 3/4 x 11 1/8	891	86	2
WEST2114	20 5/8 x 13 3/4 x 2 7/8	22 1/8 x 15 1/8 x 4	19 3/16 x 11 3/8	733	31	2

* 350° F, UL Listed, 1-Hr fire rated wall safe. **Specify suffix -K = Camlock



UNDERCOUNTER SAFES

UNDERCOUNTER SAFES

AMSEC'S UNDERCOUNTER SAFES limit excess cash register funds by providing instant protection for interim deposits of cash or checks via the anti-fish deposit slot. Securely positioning the safe next to the cash register limits exposed cash and reduces the threat of robbery and internal theft. Adaptable for multi-unit installation use, ideal for gun control, staff use, athletics clubs, security areas and much more.

OPTIONS:

single key camlock
with two keys.
(option #1)

7 pin radial key
lock, equipped with 2
keys (option #1-T)

U.L. listed
security single key
lock supplied with two
Medeco's restricted
keys protect against
unauthorized key duplication.
(option #2)

sturdy safe deposit key
lock, two keys required to open
(option #4)

removable core key
lock supplied without core. A
removable core system lets
change the combination
lock in seconds and
easily expand to include
other safes. Supplied
with removable core. (Lock option
without core).

the Group II key
lockable combination
lock offers 1 million possible
combinations. (Lock option #6).

full custom key control
lock designed to your
specific requirements:

Master Keyed

Identical Alike

Identical Different



(LOCK OPTION #1T)
TB0610-1T
Chicago 7 pin camlock



(LOCK OPTION #1)
TB0610-1 OR
TB0610-1 OR
Chicago single key
camlock



(LOCK OPTION #4)
TB0610-4 OR
TB0610-4 OR
Dual custody safe
deposit key lock



(LOCK OPTION #2)
TB0610-2 OR
Medeco® single key camlock



(LOCK OPTION #7)
TB0610-7
Best removable core
key lock



HEAVY DUTY SERIES

MODEL K1 AND K2

- 1/4" thick A36 solid steel plate hinged door.
- Full width slot over door.
- A saw tooth baffle guards against pilferage or fishing.
- Your choice of U.L. listed dual control keylock (K-2), a single key Medeco® lock (K-1), or a Chicago single key lock (K-1A).
- "B" Rate steel construction.
- May be installed vertically or horizontally.
- May be mounted on or under counter as space permits.
- Durable, impact resistant Charcoal Gray textured finish.

Model	Inside Dimension H" x W" x D"	Outside Dimension H" x W" x D"	Clear Door H" x W"	Cu. In. Cap	Wt. Lbs
TB0610(*)	5 ⁷ / ₈ x 5 ⁷ / ₈ x 8 ³ / ₈	6 x 6 x 10	5 ⁷ / ₈ x 5	289	6
K-1 / K2	5 ⁵ / ₈ x 5 ⁵ / ₈ x 10	6 x 6 x 12	3 ¹³ / ₁₆ x 5	316	16

NOTE: Models TB0610, TB0612 & TB1210 are available with the LaGard 33E electronic lock. (Factory installed primary lock.)

IMPORTANT:

AMSEC Undercounter safes are recommended for an operation that requires a non-returnable deposit. These safes are not meant for overnight storage of cash



NEW! RETAIL MONEY MANAGER SAFE

AMSEC's NEW RETAIL MONEYMANAGER SAFE offers unrivaled value in electronic safe access. Built tough to maximize protection against burglary attempts, the Retail MoneyManager has all the advanced features necessary for commercial applications.

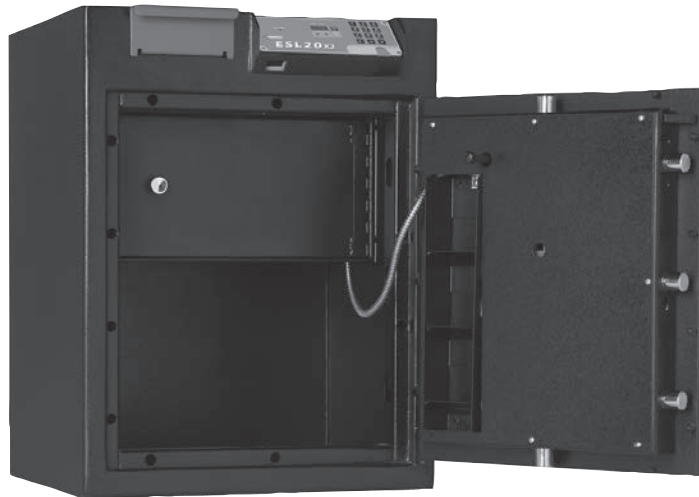

Safe Features:

- Solid steel 1/2" thick door equipped with 10 solid steel Anti-Spread Pins
- Formed high tensile steel body and jamb construction to maximize protection against pry attack.
- Provided with 6 removable door mounted coin racks
- Reinforced internal jambs on all four sides provide protection against sledgehammer attack.
- 3-way locking system with five 1" dia. Chrome plated locking bolts.
- Bolt detent system engages boltwork and locks the door automatically.
- Auxiliary spring-loaded reloading devices.
- Locks and relocks protected by a large carburized hardplate.
- Standard Four (4) anchor bolt holes.

Interior Locker Features:

- Heavy 1/4" steel door, 9-1/4" H x 19-3/4" W x 13-1/2" (12-7/8" Clear) D
- Large clear door opening: 6-9/16" H x 14" W
- Locker door closes when outer door is closed.

Deposit Drawer Features:

- Large "fish" and "pry" resistant solid steel deposit drawer deposits.
- Drawer size: 2" x 4-1/4" x 9-1/2"

Lock Features:

- The Retail MoneyManager Safe comes with your choice of either the AMSEC SafeWizard® Electronic lock or the AMSEC ESL20x2 Electronic lock.

See Page 40 for more information on SafeWizard® and ESL20X2 Electronic Locks



Part #	Description	Inside Dim. (H x W x D)	Outside Dim. (H x W x D)	Clear Door	Wt. Lbs.
RMM2620X2-R	C-Store Cash Management Safe Right Swing / with ESL20x2	25 3/4" x 19 3/4" x 15 5/8"	26" x 20" x 18 1/2"	18 1/4" x 15 1/2"	280
RMM2620X2-L	C-Store Cash Management Safe Left Swing / with ESL20x2	25 3/4" x 19 3/4" x 15 5/8"	26" x 20" x 18 1/2"	18 1/4" x 15 1/2"	280
RMM2620SW-R	C-Store Cash Management Safe Right Swing / with SafeWizard®	25 3/4" x 19 3/4" x 15 5/8"	26" x 20" x 18 1/2"	18 1/4" x 15 1/2"	280
RMM2620SW-L	C-Store Cash Management Safe Left Swing / with SafeWizard®	25 3/4" x 19 3/4" x 15 5/8"	26" x 20" x 18 1/2"	18 1/4" x 15 1/2"	280

The **SAFEWIZARD®** Electronic Safe Controller is a state-of-the-art electronic product for use in controlling and auditing access to safes. Designed to prevent burglaries and internal theft, the **THE SAFEWIZARD®** controls and documents each access to the safe. Based on contemporary high speed processors, unique user friendly software techniques and ingenious application ideas, this system surpasses all other safe access control systems.

BSW STANDARD FEATURES:

DOOR:

- Massive ½" thick solid steel plate with formed body and jamb for maximum protection.
- 3-way locking mechanism using five 1" chrome plated locking bolts with bolt detent that automatically engages boltwork.
- Lock protected by a carburized hardplate with auxiliary spring loaded relocker.

INTERIOR FEATURES:

- Heavy ¼" steel door, with slam-bolt lock controlled by the SafeWizard® and a large clear door opening of 6"H x 14"W(*) or 6"H x 19"W (†).
- Large "fish" resistant, pull out drop drawer accepts filled envelopes.
- See chart below for locker dimensions and storage below locker dimensions.

THE SAFEWIZARD® FEATURES:

- A powerful processor based on the ColdFire® 32 bit microprocessor.
- Up to 10,000 audit entries and 40 users.
- Controls up to 6 safe doors and 1 deposit lock. Safe doors can be configured in any inner-outer arrangement. Man Trap feature to maintain security in a safe room so the Entry Door and the Safe can't be opened at the same time.
- Time Delay any door with a 1-99 minute delay and 1-99 minute open period with cancel feature.
- Time Lock any door, 1-6 windows per day.
- Authentication options: PIN code and/or Dallas Key access control, optional Finger Print Reader or Card Swipe devices are available.
- Wrong Try Count Penalty Lockout.
- Auto-Purge Idle Users option, selectable by Individual User.
- Forced PIN Changes to decrease risk of compromised PINs.
- Armored Car courier Time Delay and Lock Bypass.
- Duress/Hold-up Alarm with Silent Signal.
- Burglary Alarm output triggering from selectable events.
- Holiday Schedule with up to 16 programmable events per year.
- Automatic Daylight Savings Adjustment, selectable and configurable.
- Dual Control Mode on any individual door, selectable by user.
- Built-in key maker, complete with management tool set, audit trail sorting by several criteria.
- Deposit Tracking system to provide the highest level of cash management security.
- Audit utility allows PC based audit storage management, data filter and sorting capabilities and excellent exception reporting to focus on key security issues.
- Other Remote Administration Functions: Set safe clock, time delay settings, duress, pin reject mode, repeating holidays and much more!

See page 40 for additional information.

- Ultra-high contrast 8 line by 21 character graphics display.
- Rechargeable Battery Backup.
- Built-in System Diagnostics.
- Parallel Printer Interface.
- English and Spanish language options.



For More SafeWizard® Features See Page 40

Model	Inside Dimension H x W x D	Outside Dim. H x W x D	Clear Door Safe Only	Cu. In.	Wt.	No. of Shelves
BSW2020	LOCKER: 6 1/8 x 19 3/4 x 13 1/2 STORAGE: 9 1/8 x 19 3/4 x 17	22 x 20 x 20	14 3/4 x 16 1/4	1,633 3,022	190	0
BSW3020	LOCKER: 6 1/8 x 19 3/4 x 13 1/2 STORAGE: 19 1/8 x 19 3/4 x 17	32 x 20 x 20	24 3/4 x 16 1/4	1,633 6,380	226	2
BSW4020	LOCKER: 6 1/8 x 19 3/4 x 13 1/2 STORAGE: 29 1/8 x 19 3/4 x 17	42 x 20 x 20	34 3/4 x 16 1/4	1,633 9,737	274	3
BSW2025	LOCKER: 6 1/8 x 24 3/4 x 18 1/2 STORAGE: 9 1/8 x 24 3/4 x 22	22 x 25 x 25	14 3/4 x 21 1/4	2,804 4,900	240	0
BSW3025	LOCKER: 6 1/8 x 24 3/4 x 18 1/2 STORAGE: 19 1/8 x 24 3/4 x 22	32 x 25 x 25	24 3/4 x 21 1/4	2,804 10,345	320	2
BSW4025	LOCKER: 6 1/8 x 24 3/4 x 18 1/2 STORAGE: 29 1/8 x 24 3/4 x 22	42 x 25 x 25	34 3/4 x 21 1/4	2,804 15,790	400	3



BWB SERIES - WIDE BODY CASH CONTROL

Extensive research and development went into the engineering of AMSEC'S **WIDE BODY "B" RATE CASH HANDLING DEPOSITORY SAFES**. Designed to offer complete cash management versatility with a front load depository option and a pull-out deposit drawer (Model BWB3020D1 only).



**BWB2020FL WITH
OPTIONAL SAFEWIZARD®**



BWB3020-D1



BWB2020-FL

BWB STANDARD FEATURES:

- Door: Massive 1/2" thick A36 solid steel plate.
- Formed high tensile steel body and jamb construction to maximize protection against pry attack.
- Reinforced internal jambs on all four sides to provide protection against sledgehammer attack.
- U.L. listed Group II, key changeable combination lock.
- Optional electronic locks available.
- 3-way locking mechanism consisting of five 1" diameter chromed steel locking bolts.
- Bolt detent system engages boltwork automatically.
- Locks and relocks protected by a large carburized hardplate.

- Auxiliary spring-loaded reloading devices.
- Convenient, door-mounted, recessed coin rack.
- Standard Four (4) anchor bolt holes.

INTERIOR LOCKER FEATURES:

- Heavy 1/4" steel door, and single-key camlock with two keys.
- Large clear door opening:
6" H x 12"W (for 20" W safes) or
6" H x 14"W (for 25" W safes).
- Inside Dimensions:
BWB2020 / BWB3020 / BWB4020:
8 5/8" x 19 3/4" x 14"
BWB2025 / BWB3025 / BWB4025:
8 5/8" x 24 3/4" x 19"
- Note: Front Load Depository - inside locker height restricted to 6".

DEPOSIT DRAWER FEATURES (ONLY MODEL BWB3020D1):

- Large "fish" resistant, pull out drop drawer deposits directly into standard interior locker.
Drawer size: 11 1/8" x 3 1/2" x 7 1/2"
- Heavy duty steel sliding drawer.

FRONT LOAD DEPOSITORY FEATURES:

- Recessed heavy duty 1/8" construction with 1/8" door.
- Protected by dual "anti-fish baffles."
- Large package capacity: 4" x 9" x 11 1/2" (maximum).
- May be ordered in any one of four directions. Specify front, reversed, right load or left load.

EACH UNIT COMES EQUIPPED WITH AN INTERIOR LOCKER TO ACCOMMODATE DEPOSITS, A LARGE INTERIOR FOR STORAGE OF CASH TRAYS AND A DOOR-MOUNTED, RECESSED COIN RACK.

Model	Inside Dim. H x W x D	Outside Dim.† H x W x D	Door Opening	Cu. In. Capacity	Wt.* †	No. of Shelves
BWB2020	19 3/4" x 19 3/4" x 17"	20" x 20" x 20"	14 3/4" x 16 1/4"	6,631	168	1
BWB3020	29 3/4" x 19 3/4" x 17"	30" x 20" x 20"	24 3/4" x 16 1/4"	9,988	228	2
BWB4020	39 3/4" x 19 3/4" x 17"	40" x 20" x 20"	34 3/4" x 16 1/4"	13,346	296	3
BWB2025	19 3/4" x 24 3/4" x 22"	20" x 25" x 25"	14 3/4" x 21 1/4"	10,754	235	1
BWB3025	29 3/4" x 24 3/4" x 22"	30" x 25" x 25"	24 3/4" x 21 1/4"	16,198	302	2
BWB4025	39 3/4" x 24 3/4" x 22"	40" x 25" x 25"	34 3/4" x 21 1/4"	21,644	390	3

IMPORTANT: For all safes listed above, please note the following:

Specify: D1 = Drawer (Model BWB3020 only). Specify: FL = Front Loading Depository.

† Add 9% for Front Load Depository.

Minus 10% for clear I.D. with Locker.

* Add 50 lbs. for Front Load Depository.

IMPORTANT:

AMSEC depository safes are recommended for an operation that requires a non-returnable deposit such as armored car companies, convenience stores, restaurants, etc. The top locker is not meant for overnight storage of cash or valuables.



DS SERIES - "B" RATE ROTARY AND FRONT LOADING

DEPOSITORY SAFES

AMSEC'S DS SERIES DEPOSITORY SAFES are designed to provide immediate deposits and storage for cash, jewelry and miscellaneous valuables.

Deposits can be made through a locked door via a top-loading rotary hopper, a reverse or a front-loading deposit door.



DSC2014KC



DSF2714K

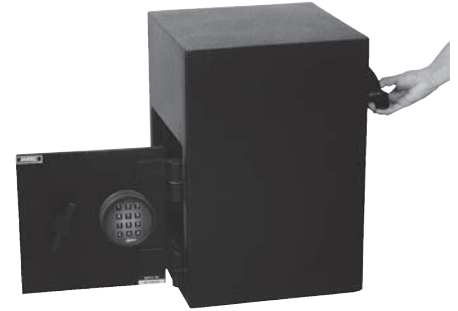

REVERSE HOPPER
DSR2014 WITH ESL10XL



DST2731KC



DSF2014
WITH ESL10XL LOCK



DSF3214CC

STANDARD FEATURES

BODY:

- Strong, formed "B" Rate construction made of A36 solid steel plate for improved security and appearance.
- Formed door jamb for increased resistance to sledgehammer attack.
- Four anchor bolt holes are standard.

DOOR - MODEL NUMBERS: 2014, 2714 AND 3214

- ½" thick A36 solid steel plate, recessed ½" to increase resistance to pry attack.
- U.L. Group II combo lock (C), U.L. listed dual nose keylock (K).
- Optional electronic locks available.
- Three 1" diameter chromed steel locking bolts.
- Bolt detent system engages boltwork automatically.
- Auxiliary spring-loaded reloading device.
- Lock and relock protected by large carburized hardplate.

ADDITIONAL FEATURES: WIDE BODY MODEL 2731

- DOOR: (3) 1" x ½" rectangular plated bolts.
- Unique space-efficient, side-by-side design creates full depth depository and large storage compartment.
- Accepts cash trays up to 13" x 18".
- Optional coin rack available on storage compartment door.

HOPPER:

- 2014/2714 are available w/reverse hopper.
- Large package sizes:
(Top Load Rotary): 4¾"D x 4¾"W x 10"L
(Front/Reverse Load): 4"D x 2¾"W x 10½"L
- Recessed, heavy duty 3/16" construction (¼" door).
- Protected by dual "anti-fish" baffles.

Model †	Inside Dim. H x W x D	Outside Dim.* H x W x D	Door Opening	Cu. In.	Wt.
DST2014	11½ x 13¾ x 11	20¼ x 14 x 14	9¾ x 9¾	1,739	87
DSF2014	10 x 13¾ x 11	20¼ x 14 x 14	9¾ x 9¾	1513	79
DSR2014	10 x 13¾ x 11	20¼ x 14 x 14	9¾ x 9¾	1513	94
DSC2014KC**	BOT 10¼ x 13¾ x 11 TOP 6⅞ x 13¾ x 12⅝	27¼ x 14 x 14	BOT 9¾ x 9¾ TOP 6 x 10⅝	1513 1127	104
DST2714	18½ x 13¾ x 11	27¼ x 14 x 14	9¾ x 9¾	2798	101
DSF2714	17¼ x 13¾ x 11	27¼ x 14 x 14	9¾ x 9¾	2609	108
DSR2714	17¼ x 13¾ x 11	27¼ x 14 x 14	9¾ x 9¾	2609	92
DST3214	TOP 12¼ x 13¾ x 11 BOT 11¼ x 13¾ x 11	32¼ x 14 x 14	9¾ x 9¾	1664 1890	152
DSF3214	TOP 11¼ x 13¾ x 11 BOT 12½ x 13¾ x 11	32¼ x 14 x 14	9¾ x 9¾	1437/1815^ 1890/1702^	144
DST2731	LEFT 18½ x 14⅞ x 18 RIGHT 27 x 16 x 18	27¼ x 30¾ x 21	LEFT 9 x 9⅞ RIGHT 22½ x 14⅞	4787 7776	285
DSF2731	LEFT 16¾ x 14⅞ x 18 RIGHT 27 x 16 x 18	27¼ x 30¾ x 21	LEFT 9 x 9⅞ RIGHT 22½ x 14⅞	4399 7776	276

IMPORTANT:
AMSEC depository safes are recommended for an operation that requires a non-returnable deposit such as armored car companies, convenience stores, restaurants, etc. The top locker is not meant for overnight storage of cash or valuables.

†Specify Prefix: T=Top Loading, F=Front Loading, R=Reverse Hopper, K=Key Lock, C=Combo Lock, E=Electronic Lock
*Add 2" to outside depth for dial and handle projection.
**Camlock on locker, combination on deposit safe.
^Cubic inch capacity on DSF3214 change for CC and KK

MONEY MANAGER



AMSEC's "B" Rate Money Manager Series Undercounter Two Door Depository Safes are the most effective cash handling systems available. Engineered to help you achieve total cash control.

AMSEC's Money Manager Series is recommended for any operation that requires a non-returnable deposit such as armored car companies, convenience stores, restaurants, etc. The secured deposit and receiving compartments protect against mysterious disappearance and pilferage.

NEW! AMSEC's ESL20XL electronic lock is now standard for this series!



MM2820EE TOP DROP W/OPTIONAL KEY LOCK



MM2820EE CENTER DROP



MM2820EE THREE DROP

STANDARD FEATURES:

- Heavy duty construction with 1/2" solid steel doors.
- Both doors equipped with AMSEC's ESL20XL electronic lock. Optional key locks available, offering dual control.
- Optional combination locks available.
- Handle activated locking mechanism consisting of three 1" diameter locking bolts.
- Bolt detent device automatically engages bolts when doors are closed.
- Auxiliary spring-loaded reloading device, activated by a punch attack.
- Locks and relocks are protected by a large carburized hardplate.
- Formed door jamb and full length dead bar.
- Coin racks are standard on inside of storage door.
- Fish resistant depository drops accept bulk items, drop envelopes or bags.
- Cash drawers and bulky items conveniently fit into both compartments.
- Four anchor bolts and anchor hardware included.
- Available as a "top drop," "center drop," or "three drop" model.
- MM2820EE front load and center drop hopper measures 16 1/4"W x 2"H x 3 1/2"D.
- Three individual color-coded 4" drops for shift control. Three deposit bins provided on "three drop" model.
- Attractive Black textured finish.

Model	Inside Dimension H x W x D	Outside Dimension H x W x D	Clear Door H x W x D	Cu. In.	Wt.
MM2820EE 3-Drop	TOP 9 1/2 x 20 x 17 BTM 11 x 20 x 17	28 x 20 1/2 x 20	8 1/2 x 16 1/4 8 1/2 x 16 1/4	3,230 3,740	247
MM2820EE Top-Drop	TOP 9 1/2 x 20 x 17 BTM 11 x 20 x 17	28 x 20 1/2 x 20	8 1/2 x 16 1/4 8 1/2 x 16 1/4	3,230 3,740	274
MM2820EE Center-Drop	TOP 10 3/8 x 20 x 17 BTM 10 3/8 x 20 x 17	28 x 20 1/2 x 20	8 1/2 x 16 1/4 8 1/2 x 16 1/4	3,230 3,740	278



BWB SERIES, US2015 AND MS1414

"B" RATE SECURITY SAFES

The many different features of the WIDE BODY SAFES, make them perfect for commercial application or home use.



BWB3020



BWB2020



**MS1414 WITH
ESL10XL LOCK**



**MS1414K WITH
SLOT OPTION**

Standard Features for BWB:

- ½" thick solid steel door, recessed for resistance to pry attacks.
- Formed, high-tensile steel body and jamb construction to maximize protection against pry attacks.
- U.L. listed Group II key changeable combination lock with over 1 million possible combinations.
- Optional electronic locks available.
- Auxiliary spring-loaded relock device.
- Locks and relocks protected by a large carburized hardplate.
- Attractive Black textured finish.
- BWB: Four anchor bolt holes with hardware.

Additional BWB Series Features:

- Reinforced internal jambs on all four sides to provide excellent protection against sledgehammer attack.
- 3-way locking mechanism consisting of five massive 1" diameter chromed steel locking bolts.
- Bolt detent system keeps bolts retracted when the door is open, then automatically engages when door is shut.
- Convenient door mounted recessed coin rack.
- Large capacity for storage of cash trays.
- Adjustable shelves.

Mini Safe (MS Series) Features:

- Strong, formed "B" Rate construction made of A36 solid steel plate for improved security and appearance.
- Formed door jamb for increased resistance to sledgehammer attack.
- ½" solid steel door.
- U.L. Group II combo lock (C), U.L. listed dual nose keylock (K).
- Three 1" diameter chromed steel locking bolts.
- Bolt detent system engages boltwork automatically.
- Auxiliary spring-loaded relocking device.
- Lock and relock protected by large carburized hardplate.
- Four anchor bolt holes with hardware.
- Adjustable shelf provided.
- Also available with optional deposit slot. (shown above) Slot size: ½" H x 6 W"

Model	Inside Dim. H x W x D	Outside Dim.* H x W x D	Door Opening	Cu. In. Capacity	Wt.	Shelves
BWB2020	19¾ x 19¾ x 17	20 x 20 x 20	14¾ x 16¼	6,631	154	1
BWB3020	29¾ x 19¾ x 17	30 x 20 x 20	24¾ x 16¼	9,988	218	2
BWB3025	29¾ x 24¾ x 22	30 x 25 x 25	24¾ x 21¼	16,198	306	2
BWB4020	39¾ x 19¾ x 17	40 x 20 x 20	34¾ x 16¼	13,346	272	3
BWB4025	39¾ x 24¾ x 22	40 x 25 x 25	34¾ x 21¼	21,644	440	3
MS1414	13¾ x 13¾ x 11	14 x 14 x 14	9¾ x 9¾	2,080	67	1

*Add 2" to outside depth for handle, dial and hinge projection.

BLB AND BLC SERIES



AMSEC "B" AND "C" RATE SECURITY CHESTS are designed to provide secure storage at an economical price. In addition to meeting the requirements of the Insurance Offices Manual of Burglary Insurance, these units offer an appearance and many features similar to AMSEC'S higher rated TL-15 models.



BLC3018

STANDARD FEATURES

DOOR:

- 1" ("C" Rate), or ½" ("B" Rate) steel pry-resistant recessed door.
- U.L. listed Group II key changeable lock, with relock and 1 million possible combinations.
- Additional spring loaded reloading device, activated by a punching attack.
- Locks and relocks protected by a large carburized hardplate.
- A handle activated locking mechanism consisting of three 1" chromed steel locking bolts. (five in BLB and BLC4024 models).
- Solid steel full length dead bar prevents door removal if hinges are removed during a forced entry attempt.
- Adjustable ball bearing hinges.

BODY:

- ½" continuously welded ("C" rate) or 1/4" ("B" Rate) solid steel bodies.
- Body reinforcing frame gives the appearance of 1" thick walls to discourage attack.
- Adjustable shelves.
- Attractive Gray textured finish. Other colors available.
- Custom sizes, interior options and high security features available.
- Left swing door optional.

B-Rate Premium Free Standing Security Chest

Model	Inside Dimension	Outside Dimension	Clear Door	Cu. In.	Wt.	Shelves
BLB2018	20 x 18 x 12	20½ x 18½ x 15	18 x 16	4,320	218	2
BLB3018	30 x 18 x 16	30½ x 18½ x 19	28 x 16	8,640	312	2
BLB3024	30 x 24 x 20	30½ x 24½ x 23	28 x 22	14,400	360	3
BLB4024	40 x 24 x 20	40½ x 24½ x 23	38 x 22	19,200	445	4

* Add 2" to outside depth for handle, dial and hinge projection. Custom design available on request.

C-Rate Premium Free Standing Security Chest

Model	Inside Dimension	Outside Dimension	Clear Door	Cu. In.	Wt.	Shelves
BLC2018	20 x 18 x 12	21 x 19 x 16	18½ x 16½	4,320	370	2
BLC3018	30 x 18 x 16	31 x 19 x 20	28½ x 16½	8,640	550	2
BLC3024	30 x 24 x 20	31 x 25 x 24	28½ x 22½	14,400	740	3
BLC4024	40 x 24 x 20	41 x 25 x 24	38½ x 22½	19,200	925	4

* Add 2" to outside depth for handle, dial and hinge projection. Custom design available on request.

U.L. LISTED 2-HOUR FIRE AND IMPACT SAFES

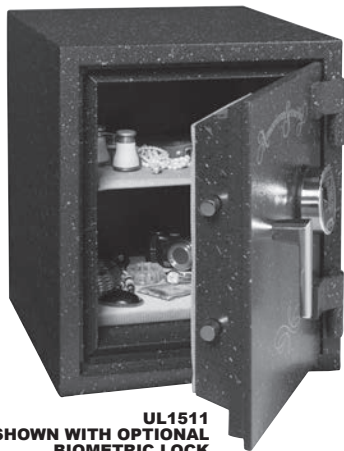

UL1511
SHOWN WITH OPTIONAL BIOMETRIC LOCK



UL1812



OPTIONAL LED LIGHT KIT WITH MOTION SENSOR AVAILABLE FOR ALL MODELS. SEE PAGE 27 FOR DETAILS.

FEATURES:

- The best warranty in the business. Lifetime fire replacement and one year parts and labor.
- U.L. listed Class 350°F two hour fire and impact rating.
- Safes withstand fires of up to 1850°F for two hours and a 30' drop – equivalent to falling through a 2 story burning building.
- Increased barriers for burglary protection. Impressive 3½" thick recessed door with 5/8" thick front for excellent pry resistance.
- Handle activated locking mechanism with 7/8" diameter solid steel chrome plated locking bolts offering smooth operation.
- Internal anchor bolt hole with hardware.
- U.L. listed Group II key changeable combination lock with relock. 1 million possible combinations.
- Auxiliary spring-loaded relock device activated by severe attack.
- Heavy duty steel hinges provide additional security and smooth operation.
- For your convenience, rubber feet are standard on models UL1511 – 1812XD.
- Heavy duty rolling casters on UL2018 and up.
- Attractively accented with a brass-plated dial, brown powder coated handle, decorative emblems and plush velour interior.
- Available in durable Sandstone or Granite textured finishes.

U.L. Safes Lifetime Replacement Warranty:

All AMSEC U.L. Listed fire safes are protected by a LIFETIME FREE REPLACEMENT GUARANTEE, assuring the original owner free replacement of safes that are damaged beyond repair by a fire with a current production model of comparable value. The damaged safe must be returned freight prepaid to the factory within 30 days of the loss, accompanied by a properly filed fire department report.

Model	Inside Dim. H x W x D	Outside Dim. H x W x D	Door Opening	Cu. In. Capacity	Wt. Lbs.	Interior Shelves
UL1511(*)(**)	15½ x 11½ x 12	21¼ x 17 x 18½	14¾ x 11¼	2,139	246	1
UL1812(*)(**)	18½ x 12½ x 12	25 x 18 x 18½	18½ x 12½	2,775	272	1
UL1812X(*)(**)	18½ x 12½ x 17	25 x 18 x 23	18½ x 12½	3,931	298	1
UL2018(*)(**)	20 x 18 x 18	30¼ x 25½ x 25½	20 x 18	6,480	542	2
UL2818(*)(**)	28 x 18 x 18	38¼ x 25½ x 25½	28 x 18	9,072	702	2
UL3918(*)(**)	39 x 18 x 18	49¼ x 25½ x 25½	39 x 18	12,636	808	2

* ADD 2" FOR HANDLE, DIAL AND HINGE PROJECTION. OUTSIDE HEIGHT INCLUDES 1" HIGH RUBBER FEET ON MODELS UL1511-UL1812XD; 2¾" FOR CASTERS ON THE THREE LARGEST MODELS. Hardware on above safes specify (*): Brass (LTG) on Sandstone and Chrome (LTE) on Granite Color Options Specify (**): (GR) = Granite, (ST) = Sandstone

U.L. FIRE RESISTIVE RATING CLASSIFICATION

THE FOLLOWING IS AN EXPLANATION OF THE UNDERWRITER'S LABORATORIES' FIRE RESISTANT CONTAINER TESTING PROCEDURES ON THE CLASS 350°F, ONE HOUR AND TWO HOUR FIRE LABELS.

U.L. Label/Class 350°F-one hour and Class 350°F-two hour. The safe will maintain an interior temperature less than 350°F when exposed to fire for a period of one hour at 1700°F or for a period of two hours at 1850°F. Safe must successfully undergo all other requirements for the Fire Endurance Test, Explosion Hazard Test and the Fire/Impact Test as stated below.

FIRE ENDURANCE TEST

After heat sensors and paper are placed inside the safe, the unit is locked and exposed to a uniformly distributed fire. The furnace is regulated to reach a maximum temperature of 1700°F for a period of one hour, or 1850°F for two hours, then allowed to cool without opening the furnace. The interior temperature is recorded throughout the test and during the cooling period until a definite drop is shown and must never exceed 350°F.

Once cooled, the unit is opened and examined for usability. The units locking mechanisms and parts fastenings are examined for security and the interior examined for visible evidence of undue heat transmission.



EXPLOSION HAZARD TEST

The safe is locked and placed into a furnace preheated to 2000°F. This temperature is maintained for 30 minutes (2 hour test is 45 minutes) and if no explosion results, the unit is allowed to cool without opening the furnace doors. Once cooled, the unit is opened and examined for usability. The units locking mechanisms and parts fastenings are examined for security and the interior examined for visible evidence of undue heat transmission.

FIRE IMPACT TEST (MANUFACTURER'S OPTION)

After the explosion hazard test the safe is removed from the furnace and within two minutes is dropped 30' onto a riprap of brick on a heavy concrete base. After impact the unit is examined for deformation, rupture of parts, damaged insulation and any other openings into the interior of the unit. Once cooled, the unit is inverted and reheated to 1550°F for a period of 30 min. (2 hour test: 45 min. at 1638°F).

Once cooled, the unit is opened and examined for usability. The units locking mechanisms and parts fastenings are examined for security and the interior examined for visible evidence of undue heat transmission.

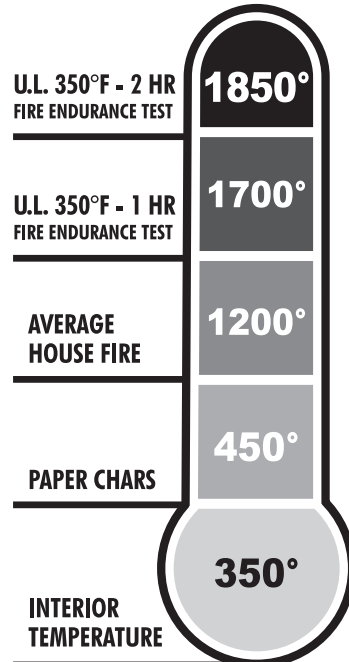

U.L. LISTED FIRE RATED BURGLARY SAFES



The AMSEC BF® SERIES offers a unique design that combines all the security features of a burglary safe and the peace of mind achieved with a fire safe. The industry's first U.L. Listed, fire-rated burglary safe offers an affordable solution when burglary and fire protection are an essential part of your buying decision!

During Underwriter's Laboratories grueling testing procedures, the BF® SERIES earned the U.L. Listed Class 350°F One Hour Fire Label and the (RSC) Residential Security Container Burglary Label.



BF3416ST
SHOWN WITH
OPTIONAL STORAGE
CABINETS (PG 45)



BF2116



BF1512

FEATURES

- The best warranty in the business. Lifetime fire replacement and one year parts and labor.
- "B" rated heavy duty construction.
- 1-Hr. 350°F factory fire rating. Tested at temperatures up to 1700°F.
- U.L. listed Group II lock with spring-loaded auxiliary relock device.
- ¼" heavy duty carburized hardplate.
- Heavy duty steel hinges provide easy smooth door operation.
- One recessed anchor bolt hole and mounting hardware are provided to securely anchor safe.
- Attractively accented with a large chrome-plated dial, matching handle and a plush velour interior.
- Durable and attractive granite finish or sandstone textured with a plush velour interior. Optional high-gloss finishes available.
- Optional electronic locks are available. **SEE PAGES 41-43.**
- Optional storage cabinets available on models BF3416 and BF1716. **SEE PAGE 45.**

Door:

- 3½" thick, consisting of ½" plate steel with a unique proprietary fire and burglary resistant material.
- Dual seal design utilizes a silicone foam seal with a heat-expanding intumescent seal.*

Body:

- 2⅝" thick, consisting of ⅜" outer and inner steel plates creating a burglary resistant structure enclosing a unique proprietary fire resistant material.
- Three massive 1" diameter solid steel chrome-plated locking bolts.
- A full length dead bar locks deep into the body preventing door removal during a forced entry attempt.



OPTIONAL LED LIGHT KIT WITH MOTION SENSOR AVAILABLE FOR ALL MODELS. SEE PAGE 27 FOR DETAILS.

BF® Safes Lifetime Replacement Warranty:

If your BF® safe is exposed to fire and failed to protect the contents, your BF® safe will be replaced free of charge. Just return the safe freight prepaid to the factory accompanied with the fire report. Contact your dealer for further details.



*INTUMESCENT DOOR SEAL:

When the intumescent seal is exposed to high temperature (above 250°F), it expands to as

much as 8 times it's original thickness. In this expanded or reactive state, it has very high thermal insulating capacity and resistance to breakdown. This provides a strong positive seal between the door and body, preventing heat influx.

Model	Inside Dim. H x W x D	Outside Dim. ^ H x W x D	Door Opening	Cu. In. Capacity	Wt. Lbs.	Interior Shelves
BF1512(*)(**)	15 x 12 x 13	20¼ x 17¼ x 18¾	15 x 12	2,340	288	1
BF1716(*)(**)	17 x 16½ x 16	22¼ x 21¾ x 21¾	17 x 16½	4,488	412	1
BF2116(*)(**)	21 x 16½ x 14½	26¼ x 21¾ x 20¼	21 x 16½	5,024	476	1
BF3416(*)(**)†	34 x 16½ x 16	39¼ x 21¾ x 21¾	34 x 16½	8,976	628	2

BOLT DOWN KIT INCLUDED, ^ADD 2" FOR DIAL & HANDLE

Hardware on above safes specify (*): Brass (LTG) on Sandstone and Chrome (LTE) on Granite Color Options Specify (**): (GR) = Granite, (ST) = Sandstone

† 1/2 hour U.L. Fire Rating

CSC SERIES COMPOSITE SAFES

COMMERCIAL SECURITY SAFES

AMSEC **CSC SERIES COMPOSITE SAFES** are an affordable solution when you want to protect both documents from fire and valuables from burglary attacks. During extreme testing procedures the **CSC SERIES COMPOSITE** safes passed a 2-Hour, 350°F factory fire test certification.



Interior temperature less than 350°F for a period of 2 Hours at 1700°F



CSC4520



CSC3018 WITH OPTIONAL STOR-IT CABINET



CSC1913

Features:

Door:

- Overall thickness of 4-5/8" and is constructed with a 2" defense barrier of outer and inner steel plates creating a burglary resistant structure enclosing a unique proprietary, fire resistant material.

Body:

- Total protective thickness of 2-7/8" enclosing a unique, high-density fire and burglary resistant composite material.
- Durable powder coated adjustable shelves.
- Removable casters provide easy delivery and installation.

Fire Endurance:

- 2 hour, 350°F factory fire rating. Tested at temperatures up to 1700°F.
- Heat expandable intumescent door seal guards contents against severe fires.

Locking Mechanism:

- Two to four 1½" diameter solid steel chrome-plated locking bolts.
- Two to three 1½" diameter solid steel dead bolts lock deep into body preventing door removal during a forced entry attempt.
- U.L. Listed Group II combination lock with chrome-plated spy-proof dial. Optional electronic locks available.
- Lock protected by a tempered glass relock device.
- Heavy duty steel hinges provide easy, smooth door operation.
- One internal counter-sunk anchor hole and mounting hardware are provided to securely anchor safe.
- Attractively accented with a full width fascia panel and matching three point handle,
- Durable and attractive charcoal gray textured finish.



CSC1413



OPTIONAL STORAGE CABINETS AVAILABLE IN MODELS CSC3018 AND CSC4520. NO KIT NEEDED, DRAWERS SLIDE RIGHT IN. SEE PAGE 45 FOR MORE DETAILS

Model	Inside Dim H x W x D	Outside Dim H x W x D	Weight	Cubic In. Capacity	Bolts	Shelves	Rubber Feet or Casters
CSC1413	14 x 12.5 x 12.2	19.5 x 18 x 19.9	256	2,135	4	1	Rubber Feet
CSC1913	19 x 12.5 x 12.2	23.8 x 18 x 19.9	318	2,898	4	2	Rubber Feet
CSC3018	30 x 18 x 16.3	35.5 x 23.5 x 24	462	8,802	7	3	Casters
CSC4520	45 x 20 x 21.2	50.5 x 25.5 x 28.9	768	19,080	7	4	Casters

* Add 2" to outside depth for handle, dial and hinge projection.

* Add 4¼" (casters) and 1" (rubber feet) to outside height.



OPTIONAL LED LIGHT KIT WITH MOTION SENSOR AVAILABLE FOR ALL MODELS. SEE PAGE 27 FOR DETAILS.

IMPORTED U.L. LISTED 1-HR FIRE SAFES

ELECTRONIC AND COMBO



The economical range of our **IMPORTED RESIDENTIAL FIRE SAFES (ELECTRONIC and COMBO)** is the answer's to today's high incidence of residential fires. Our Fire Safes also provide burglary protection making them ideal for home and light commercial applications. Our FS2215 **IMPORTED COMMERCIAL FIRE SAFE** is larger and perfect for both commercial and residential applications.



NEW! IMPORTED RESIDENTIAL FIRE SAFES (ELECTRONIC)

FEATURES:
EST712, EST914 / EST149 / EST1814:

- U.L. Listed 350°F, 1-Hour fire rating.
- Side boltwork mechanism incorporating two 1/2" diameter steel deadbolts prevent door removal during a forced entry attempt. (EST1814 model: 1 x 4-1/2" rectangular steel deadbolts).
- New State-of-the-art DL5000 electronic lock with a large 3 3/4" touch screen LCD input display allows smooth and easy operation.
- Mode altering display changes from orange in standby mode to bright blue in the open position.
- Accepts (2) user codes and can show open door records for the past 14 entries.
- LCD touch screen display shows low-battery indicator, time, date and keypad.
- Emergency key-lock override system with two (2) keys, power override battery box, built-in spy-proof function and motion detector alert.

- One (1) drawer shelf and one (1) internal anchor hole with hardware.
- Impressive 1/2" thick door with attractive two-toned sage finish (EST1814 model: 5/8" thickness).
- Four (4) rubber feet. (EST1814 model has four rolling casters).

IMPORTED RESIDENTIAL FIRE SAFES (COMBO)

FEATURES:
FS914 / FS149:

- U.L. Listed 350°F 1-Hour fire rating.
- Models FS914 and FS149 have one (1) internal anchor hole and hardware, four (4) rubber feet and one (1) drawer shelf (except model FS712 that has a removable shelf).
- Key operated side-locking mechanism incorporating two chromed locking bolts.
- Two deadbolts prevent door removal if hinges are removed during a forced entry attempt.
- Attractive two-toned sage finish.

FS2215 IMPORTED COMMERCIAL FIRE SAFE

FEATURES:

- U.L. Listed 350°F 1-Hour fire rating.
- Model FS2215 offers a Group 2 combination lock with a Spyproof dial and ring, one (1) key-lock drawer, two (2) adjustable shelves, four (4) rolling casters for ease of movement and additional chrome "L" handle.
- Automatic relocking device triggered by force entry attempt.
- Handle operated side, top and bottom locking mechanism incorporating four to six steel chromed locking bolts.
- Two to three steel deadbolts prevent door removal if hinges are removed during a forced entry attempt.
- Ball bearing hinges for ease of operation.
- Attractive two-toned sage finish.



OPTIONAL LED LIGHT KIT WITH MOTION SENSOR AVAILABLE FOR ALL MODELS. SEE PAGE 27 FOR DETAILS.

Residential Fire Safes (Electronic and Combo)

Model	Inside Dim	Outside Dim**	Clear Door	Cu. In.	Wt.	Shelves/Drawers
EST712	7¼ x 11⅜ x 8¾	11¾ x 16½ x 14⅛	7¼ x 11⅜	660	70	1
EST914	8½ x 14 x 10½	13½ x 19⅞ x 15¾	8½ x 14	1,250	96	1
EST149	14 x 8½ x 10½	19⅞ x 13½ x 15¾	14 x 8½	1,250	96	1
EST1814	18¼ x 13⅞ x 12⅞	23⅝ x 18⅞ x 18⅞	18¼ x 13⅞	2,920	187	1
FS914	8½ x 14 x 10⅝	13½ x 19⅞ x 15¾	8½ x 14	1,250	96	1
FS149	14 x 8½ x 10⅝	19⅞ x 13½ x 15¾	14 x 8½	1,250	96	1

Commercial Fire Safes

Model	Inside Dim	Outside Dim**	Clear Door	Cu. In.	Wt.	Shelves/Drawers
FS2215	17¼ x 13⅞ x 12½	27⅝ x 19¼ x 18⅞	17¼ x 13⅞	2,786	225	2 / 1

** Add 2" for handle, dial and hinge projection.

Model FS2215 has one key-lock drawer and two adjustable shelves.

Outside height includes casters on model FS2215.

Above dimensions have been converted from metric measurements. Please allow +¼" to ¼" variation for both outer and inner dimensions listed.

NEW! ELECTRONIC SECURITY



EST2014

EST813, EST916, EST1014, EST2014

Features:

- New State-of-the-art DL5000 electronic lock with a large 3 3/4" touch screen LCD input display allows smooth and easy operation.
- Mode altering display changes from orange in standby mode to bright blue in the open position.

These small burglary resistant **ELECTRONIC SECURITY** safes are perfect for a variety of home security needs and come with AMSEC's NEW state-of-the-art DL5000 electronic touch-screen locking system.



EST813



EST916

- Accepts (2) user codes and can show open door records for the past 14 entries.
- LCD touch screen display shows low-battery indicator, time, date and keypad.
- Emergency key-lock override system with two (2) keys, power override battery box, built-in spy-proof function and motion detector alert.
- Heavy 14 gauge solid steel construction, plus dual live bolts made also of heavy gauge steel.
- Can be bolted to the wall or floor.
- Carpeted base.
- Pry-resistant recessed door with internal hinges for anti-theft protection.
- Mounting feet and anchor hardware standard.
- Models EST1014 and EST2014 have one removable shelf.
- Warranty: 1 year parts and labor.

Model	Inside Dimension	Outside Dimension	Clear Door	Cu. In.	Wt.
EST813	7 ^{11/16} x 12 ^{13/16} x 5 ^{1/2}	7 ^{7/8} x 13 x 7 ^{3/4}	5 ^{5/8} x 9	498	16
EST916	8 ^{13/16} x 16 ^{11/16} x 12	9 x 16 ^{7/8} x 14 ^{1/8}	6 ^{3/4} x 13	1,765	30
EST1014	9 ^{9/16} x 13 ^{11/16} x 7 ^{3/4}	9 ^{3/4} x 14 ^{1/8} x 9 ^{3/4}	7 ^{5/8} x 10 ^{1/4}	1,032	22
EST2014	18 ^{11/16} x 13 ^{3/16} x 10	18 ^{7/8} x 13 ^{3/8} x 12	16 ^{3/4} x 9 ^{1/2}	2,464	45

CASH BOX AND KEY CABINET



CB23 Cash Box with Key Lock

Features 5 cash-compartment tray. Additional storage compartment and carry handle. Powder-coated finish.

Outside Dimensions: 3^{9/16} H x 11^{13/16} W x 9^{7/16} D

Weight: 4.6 lbs



KB93 Key Cabinet with Key Lock (93 Keys capacity)

Solid steel construction with powder-coating finish. Includes pre-drilled holes and screws for mounting it to a drawer or wall. Holds 93 keys with number tags.

Outside Dimensions: 11^{13/16} H x 9^{7/16} W x 3^{1/8} D

Weight: 6 lbs



NEW! IN-ROOM ELECTRONIC SAFES

AMSEC's **IN-ROOM ELECTRONIC SAFE**, with its easy installation, maintenance and management features has become a popular safe in the hospitality industry. Designed with the traveling guests in mind, the IRC916E will adequately secure laptop computers, cameras, jewelry and other valuables in the most user-friendly safe made.



**ALSO AVAILABLE:
THE IRC412
DRAWER SAFE.
SEE PAGE 30
FOR MORE
INFO**

IRC916E

- Lock-out penalty if the combination is entered wrong, the safe will lock up for 15 minutes, frustrating the would-be burglar.
- Emergency key-lock override system with 2 keys.
- Spacious interior fits most lap top computers.
- Two anchor holes with mounting hardware included.
- Attractive carpeted bottom hides anchor bolts.
- Electrostatic powder-coated finish in textured black.
- Guest instruction label included.
- Packaged for UPS shipment.

STANDARD FEATURES:

- Heavy duty steel construction offers excellent burglary protection.
- Convenient motorized locking system, incorporating the latest technology.
- Easy to read, large LED display lets you know the status of the safe.
- 4 digit combination, standard hotel room configuration (customer sets new combination every time safe is used, quickly and easily), or electronic credit card.
- Reliable ADA approved keypad.
- Runs on 4 AA batteries. If batteries should go dead, each safe has a bypass power cable (9v battery required).

OPTIONS:

- Hand-held, programming device, offering audit trail and electronic override (IRCPROG).

Model	Inside Dimension H x W x D	Outside Dimension H x W x D	Clear Door	Cu. In. Capacity	Wt. Lbs.
IRC916E	8 ¹³ / ₁₆ x 15 ¹³ / ₁₆ x 12	9 x 16 x 14	6 ⁹ / ₁₆ x 13	1672	29

NEW! ESF1214 FINGERPRINT SAFE



ESF1214

FEATURES:

- State-of-the-art fingerprint electronic lock.
- Motorized bolt work system with 2 chrome-plated solid-steel locking bolts.
- Spring-assisted door auto opens when unlocked.
- New laser-cut arched door design with heavy-duty 7/16" solid steel door and casing.
- 1/8" thick solid steel body.
- Attractive textured black finish.
- 1 adjustable shelf.
- Includes: 1 emergency key-lock with 2 keys and anchor kit.
- Large 1,692 cu. in. storage capacity.
- Warranty: 1 year parts and labor.

Model	Inside Dimension H x W x D	Outside Dimension H x W x D	Clear Door	Cu. In. Capacity	Wt. Lbs.
ESF1214	11¼ x 14½ x 12 ¹⁵ / ₁₆	11½ x 14¾ x 12¾	7 ⁵ / ₈ x 10 ¹¹ / ₁₆	1,692	54

HS SERIES - HIGH SECURITY

RF6528



RF6528-LE-F-OX-A

INTERIORS FOR RF6528:

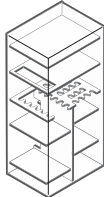

**"ALL-IN-ONE"
12-18-30 GUN**

**AMSEC GUN SAFE
NO COST LIFETIME
REPLACEMENT WARRANTY:**

- No Cost - Break-In Warranty
- No Cost - Attempted Break-In Warranty
- No Cost - Fire Warranty

See Our Gun Safe Catalog for more details.

The RF6528 Features:

- The only U.L. Listed TL-30 burglary and fire resistant gun safe on the market.
- 2¾" thick door constructed of outer and inner steel plates enclosing a unique burglary-resistant high security material and an ARMOR steel plate barrier protecting the entire door.

The HS6743 and HS7943 Features:

- U.L. Listed TL-15 burglary and fire resistant high security gun safe.
- 2¾" thick door constructed with **1" thick solid steel plate** and an inner steel plate enclosing a unique burglary-resistant, high security material.
- 3½" thick body constructed with **1" thick solid steel plate** inner wall and an outer steel plate enclosing a unique burglary-resistant, high security material.

All HS Series Safes Feature:

- Mercury Class IV fire protection of 1850°F for 2 hours. Designed to maintain an interior temperature of less than 350°F.
- U.L. listed Group 2M lock with spy-proof key-locking dial, drill shattering hard plate and two additional spring-loaded relocking devices.
- Push tan pin-dot fabric interior.
- 5-point handle in brass or chrome, convenient pull-handle and bold zinc die-cast polished brass or chrome logos.
- 10 massive 1½" solid steel chrome plated locking bolts.
- Available in several gloss and textured finishes.



HS7943 & HS6743

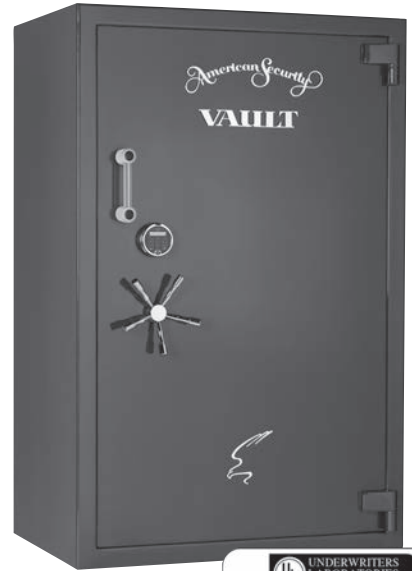

HS6743-LG-F-MM-A

INTERIORS FOR HS7943 & HS6743:

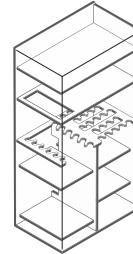

**HS7943
12-23-35 GUN**

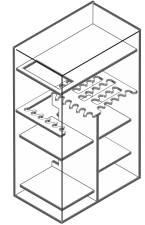

**HS6743
12-23-35 GUN**

COLOR OPTIONS FOR HS SERIES SAFES:

High-Gloss Exterior Colors:
Hunter Green Metallic (HG), Onyx (OX), Burgundy Metallic (BY), Pearl (PW), Platinum Metallic (PL), Charcoal Metallic (CM), Macadamia Metallic (MM)

Textured Exterior Colors:
Granite (GR), Sandstone (ST), Black (BK), Green (GN), NEW Chocolate Brown (CB)

Model	Outside Dimension H x W x D	Thickness (Inches)		Wt. Lbs.	Interior Capacity	Bolts
		Door (Overall / Steel Plate)	Body			
RF6528 (TL-30)	72 x 35 x 29½	5¾	3½	3,455	12-18-30	10
HS7943 (TL-15)	79 x 43 x 29½	5¾ / 1 in	3½	6,840	12-23-35	10
HS6743 (TL-15)	67 x 43 x 29½	5¾ / 1 in	3½	4,824	12-23-35	10

FIRE AND BURGLARY PROTECTION

American Security Products Co. is highly acclaimed for offering the industry's best fire protection. We manufacture the industry's broadest gamut of fire-rated products ranging from Underwriters Laboratories (U.L.) Listed 1 and 2 hour fire safes to our Mercury Class I, Class II, Class III, and Class IV fire protected gun safes.

*Each safe is designed to maintain an interior temperature less than 350°F.
Paper products will char at approximately 450°F.

Series / Model	Outside Temperature	Period (Time)	Inside Temp Less Than	U.L. Burglary Rating	Meets DOJ Standards	Warranty
RF6528	1850° F	120 Minutes	350° F	TL-30	Yes	Lifetime
HS Series	1850° F	120 Minutes	350° F	TL-15	Yes	Lifetime
BF® Series	1275° F	90 Minutes	350° F	RSC	Yes	Lifetime
SF Series	1200° F	60 Minutes	350° F	RSC	Yes	Lifetime
TF Series	1200° F	30 Minutes	350° F	B-Rate	Yes	Lifetime
TF5517	1200° F	30 Minutes	350° F	B-Rate	Yes	1-Yr Parts & Labor
CSC4520	1850° F	120 Minutes	350° F	B-Rate	Yes	1-Yr Parts & Labor
AM Series Home Safes	1200° F	30 Minutes	350° F	B-Rate	Yes	1-Yr Parts & Labor

THE BF® SERIES GUN SAFES



THE MOST UNIQUE GUN SAFE IN THE INDUSTRY



**BF6636 WITH
OPTIONAL ESL10XL
ELECTRONIC LOCK**



THE BF® SERIES FEATURES:

- ½" steel plate door (BF7250 is 3/8" steel plate) combined with 1" DryLight insulation.
- 2" total wall thickness on all sides featuring our poured DryLight insulation and two layers of steel for exceptional fire and security protection.
- U.L. Residential Security Container (RSC) Burglary Classification.
- 11 massive 1½" chrome-plated bolts. Bolt detent system holds bolts in open position.
- Mercury Class III fire protection of 1275°F for 90 minutes. Designed to maintain an interior temperature of less than 350°F.
- Commercial grade, adjustable ball bearing hinges.
- 2 Stage Dual fire seals with silicone seal on door jamb and Palusol seal on door.
- U.L. Listed Group II Lock with massive hard plate and two relocking devices.
- Spy-proof, key-locking dial with decorative five-spoke handle and convenient pull-handle.
- Unique mirrored back wall for added interior visibility.
- Bold zinc die-cast polished brass, chrome or black nickel logos.
- Premium Door Organizer (PDO) maximizes storage space and offers quick access to commonly used items. All PDO's include:
 - Various see-through pouches and zippered pockets to store valuables.
 - Two rows of holders for storage of choke tubes, small flashlights and ammo.
 - Two full-width pistol storage systems to accommodate multiple handguns. Comes with four holsters. Additional holsters can be purchased separately.
 - A long gun storage system that accommodates two guns. Includes the AMSEC exclusive "no hassle" quick release band.
- Models PDO7250 and PDO7240 offer a zippered pocket large enough to store letter size folders.
- 4 pre-cut anchor holes and 1 pre-cut electrical access hole.
- E-Z Slant-Out Interior for easy access to your long guns. Interior features rich pin-dot fabric and adjustable interior shelving.
- Available in several gloss and textured finishes.



BF7240

Shown with Optional Stor-it Cabinets and LED Light Kit

COLOR OPTIONS:

High-Gloss Exterior Colors:

Hunter Green Metallic (HG), Onyx (OX), Burgundy Metallic (BY), Pearl (PW), Platinum Metallic (PL), Charcoal Metallic (CM), Macadamia Metallic (MM)

Textured Exterior Colors:

Granite (GR), Sandstone (ST), Black (BK), Green (GN), Chocolate Brown (CB)

Two-Tone Finishes:

Onyx High-gloss door / Black Textured body or Charcoal Metallic High-gloss door / Granite Textured body

AMSEC GUN SAFE NO-COST LIFE-TIME REPLACEMENT WARRANTY:

- No Cost - Break-In Warranty
 - No Cost - Attempted Break-In Warranty
 - No Cost - Fire Warranty
- See Our Gun Safe Catalog for more details.

Model	Outside Dimension H x W x D	Thickness (Inches)		Wt. Lbs.	Interior Capacity	Bolts
		Door Overall / Steel plate	Body			
BF7250	71¼ x 50 x 28	4 ⁵ / ₈ / ½"	2	1,738	12-23-24-35-47 +2 on PDO	11
BF7240	71¼ x 40 x 26	4¾ / ½"	2	1,539	12-14-24-26-38 +2 on PDO or 58 Gun	11
BF6636	65¼ x 36 x 26	4¾ / ½"	2	1,282	12-19-31 +2 on PDO	11
BF6030	59¼ x 30 x 26	4¾ / ½"	2	1,005	11-14-25 +2 on PDO	11
BF6032	59¼ x 30 x 21	4¾ / ½"	2	885	7-11-18 +2 on PDO	11

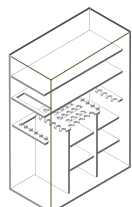

**12-23-24-35-47
GUN INTERIOR**
for Model BF7250

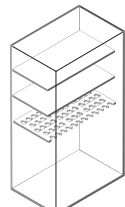

58 GUN INTERIOR
for Models: BF7240

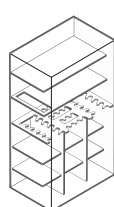

**12-14-24-26-38
GUN INTERIOR**
for Model BF7240

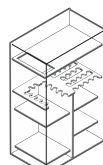

**12-19-31 GUN
INTERIOR**
for Models: BF6636

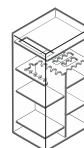

**11-14-25 GUN
INTERIOR**
for Models: RF6528, BF6030

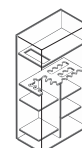

**7-11-18
GUN INTERIOR**
for Model BF6032

SF SERIES - SIXTY MINUTE FIRE



SF6030

All SF Series Safes Feature:

- 1/4" Steel Plate door with 3 layers of fire insulating material.
- Mercury Class II fire protection of 1200°F for 60 minutes. Designed to maintain an interior temperature of less than 350°F.
- 2 Stage Dual fire seals with silicone seal on door jamb and Palusol™ seal on door.
- Body constructed of 12-gauge solid steel plate with a fire insulating material.
- Group II, key-changeable lock with internal relocker, spy-proof key-locking dial and drill-resistant hardplate.
- Optional electronic lock available.
- 3-spoke handle in brass, chrome or black nickel and matching bold zinc die-cast logos.

- 4-way boltwork with 9 active 1 1/2" chrome-plated bolts and 5 deadbolts for a total of 14 bolts.
- Adjustable ball bearing hinges.
- All-velour interior.
- Four (4) pre-cut anchor holes with mounting hardware included and one (1) pre-cut electrical access hole.
- Available in several gloss and textured finishes.
- Premium Door Organizer (PDO) maximizes storage space and offers quick access to commonly used items. PDO not available on SF5924.
- Optional 4-shelf kit available



SF6030 WITH NEW STANDARD STOR-IT PDO AND OPTIONAL STOR-IT CABINETS

COLOR OPTIONS:

High-Gloss Exterior Colors:
 Hunter Green Metallic (HG),
 Onyx (OX), Burgundy Metallic (BY),
 Pearl (PW), Platinum Metallic (PL),
 NEW Charcoal Metallic (CM),
 NEW Macadamia Metallic (MM)

Textured Exterior Colors:
 Granite (GR), Sandstone (ST),
 Black (BK), Green (GN),
 Chocolate Brown (CB)

SF Two-Tone Finishes:
 Onyx High-gloss door /
 Black Textured body
 Charcoal High-gloss door /
 Granite Textured body



AMSEC GUN SAFE NO COST LIFETIME REPLACEMENT WARRANTY:

- No Cost - Break-In Warranty
 - No Cost - Attempted Break-In Warranty
 - No Cost - Fire Warranty
- See Our Gun Safe Catalog for more details.

Model	Outside Dim H x W x D	Thickness		Wt. Lbs.	Interior Capacity	Bolts
		Door (Overall / Steel Plate)	Body			
SF6036	59 x 36 x 26	4 1/4 / 1/4	12 ga	760	17-17-34 +2 on PDO	14
SF6030	59 x 30 x 26	4 1/4 / 1/4	12 ga	706	14-14-28 +2 on PDO	14
SF6032	59 x 30 x 21	4 1/4 / 1/4	12 ga	648	9-9-18 +2 on PDO	14
SF5924	59 x 24 x 18	4 1/4 / 1/4	12 ga	514	8-8-16	14

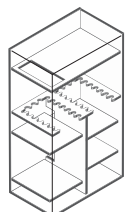

17-17-34
GUN INTERIOR
for Model: SF6036

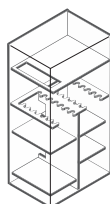

14-14-28
GUN INTERIOR
for Model: SF6030

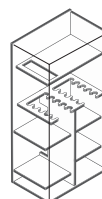

10-10-20
GUN INTERIOR
for Model: SF6032

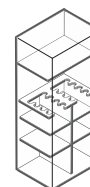

8-8-16
GUN INTERIOR
for Model: SF5924

TF SERIES - THIRTY MINUTE FIRE



TF7240E5



TF6036E5 WITH STOR-IT PDO AND OPTIONAL BATTERY OPERATED CLIP-ON LIGHT



TF5517E5

TF7240E5, TF6036E5, TF6030E5, TF6032E5 and TF5924E5 Feature:

- 3/16" Steel Plate door with 2 layers of fire insulating material.
- Mercury Class I fire protection of 1200°F for 30 minutes. Designed to maintain an interior temperature of less than 350°F.
- 2 Stage Dual fire seals with silicone seal on door jamb and Palusol™ seal on door.
- Body constructed of 12-gauge (7240 - 11ga, 5924 - 14ga) solid steel plate with a fire insulating material.
- Every TF Series gun safe now comes standard with AMSEC's ESL5 Electronic Lock with Illuminated Keypad.
- Optional Group II Combo lock available.

- 3-point chrome tri-spoke handle and bold zinc die-cast polished chrome logo.
- 4-way boltwork with 9 active 1 1/4" chrome-plated locking bolts and 5 deadbolts for a total of 14 bolts.
- Adjustable ball bearing hinges.
- Textured Black exterior and Mocha fabric interior.
- Premium Door Organizer (PDO) maximizes storage space and offers quick access to commonly used items. PDO not available on TF5924E5.
- Four (4) pre-cut anchor holes with mounting hardware included and one (1) pre-cut electrical access hole.
- Optional 4-shelf kit available.

The TF5517E5 & TF5517:

- 3/16" Steel Plate door with 2 layers of fire insulating material.
- Mercury Class I fire protection of 1200°F for 30 minutes. Designed to maintain an interior temperature of less than 350°F.
- Palusol™ door seal - expands up to 8 times its original thickness when exposed to high temperatures.
- Body constructed of 14-gauge solid steel plate with a fire insulating material.
- TF5517E5 Series gun safe now comes standard with AMSEC's ESL5 Electronic Lock with Illuminated Keypad.
- TF5517 Comes with Group II Combo lock.
- Chrome "L" handle and bold zinc die-cast polished chrome logo.
- 3-way boltwork with 5 active 1" chrome-plated bolts and 3 deadbolts.
- Textured Black exterior and Mocha fabric interior including back-cover and firewalls.
- Durable hinges.
- Four (4) pre-cut anchor holes with mounting hardware included and one (1) pre-cut electrical access hole.
- Optional 4-shelf kit available.
- Warranty: 1 Year Parts and Labor.
- PDO not available on TF5517 or TF5517E5.

Model	Outside Dim H x W x D	Thickness		Wt. Lbs.	Interior Capacity	Bolts
		Door (Overall / Steel Plate)	Body			
TF7240E5	72 x 40 x 26	3 5/8" / 3/16"	11 ga	926	15-15-15-30-45 +2 on PDO	14
TF6036E5	59 x 36 x 26	3 5/8" / 3/16"	12 ga	628	19-19-38 +2 on PDO	14
TF6030E5	59 x 30 x 26	3 5/8" / 3/16"	12 ga	572	15-15-30 +2 on PDO	14
TF6032E5	59 x 30 x 21	3 5/8" / 3/16"	12 ga	508	11-11-22 +2 on PDO	14
TF5924E5	59 x 24 x 18	3 5/8" / 3/16"	14 ga	388	8-8-16	14
TF5517E5	55 1/4 x 17 3/4 x 16	3 1/4" / 3/16"	14 ga	286	11	14

AMSEC GUN SAFE NO COST LIFETIME REPLACEMENT WARRANTY:

- No Cost - Break-In Warranty
- No Cost - Attempted Break-In Warranty
- No Cost - Fire Warranty

See Our Gun Safe Catalog for more details.

15-15-5-30-45 GUN INTERIOR 17-17-34 GUN INTERIOR 14-14-28 GUN INTERIOR 10-10-20 GUN INTERIOR 8-8-16 GUN INTERIOR 11 GUN INTERIOR

for Model: TF7240E5 for Model: TF6036E5 for Model: TF6030E5 for Model: TF6032E5 for Model: TF5924E5 for Model: TF5517E5

NOTE: AMSEC'S NO COST WARRANTY DOES NOT APPLY TO THE TF5517.

GUN SAFE ACCESSORIES AND OPTIONS

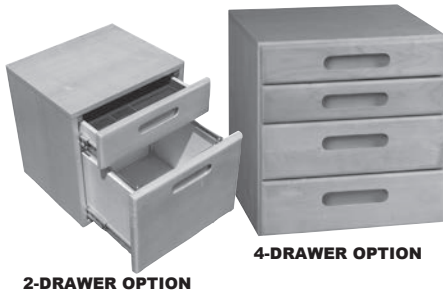

2-DRAWER OPTION

4-DRAWER OPTION

Stor-it Cabinets

Finely crafted in solid-wood maple drawer fronts and maple veneer and finished in a rich honey maple stain. NEW recessed door pulls give these cabinets a more streamlined appearance and makes for an easier fit into a variety of AMSEC safes. All drawers are lined in dark red felt with heavy-duty, ball-bearing drawer glides and include a variety of Stor-It Jewelry Organizer Inserts. Each insert can be removed for easy viewing, selecting and protection of your jewelry. **See Page 45 for more information.**



BATTERY OPERATED LIGHT KIT

This light fits any safe, yet gives off a super bright light, letting you see the contents of your safe easily. Battery operated.



PISTOL RACK

Ideal for organizing pistols inside your safe. This four gun pistol rack sits on top of an interior shelf.

LED LIGHT KITS

AMSEC introduces the new HIWL120 LED AC power light kit with built-in motion sensor. The HIWL120 has two 39" light strips with 120 high-intensity white LED's and a motion sensor that automatically turns itself on when motion is detected and turns itself off 30 seconds after you leave the area.

The new AMSEC HIWL120 LED AC power light kit can be installed on any AMSEC safe.



LED Light Kit w/Motion Sensor



Motion Sensor



DESSICANT

Prevents rust and moisture damage. Recommended for safes without electrical access.



"AR" RACKS "AR" gun racks are fully adjustable and custom fit in the side shelf area of each "BF" series gun safe. Each rack is designed with enough clearance to accommodate extra large front sights or optics. All racks feature rich pin-dot fabric.



GUNSAVER DEHUMIDIFIER

Will constantly guard your guns against the threat of rust, pitting and moisture damage. Electrical access is required.

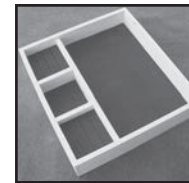

JEWELRY TRAY

Conveniently fits into every safe. Burgundy felt lined. 10-3/8" x 9-3/8" x 2"

PREMIUM UPGRADE PACKAGE FOR HS, BF® AND SF SAFES
 When you choose to upgrade your HS, BF® or SF Series safe with a "Premium Package," we'll add on some of our most popular options including a jewelry tray, a Gunsaver dehumidifier and an LED light kit with power strip.

NEW! DEFENSE VAULT

NEW! DEFENSE VAULT



The AMSEC Defense Vault puts home security where you need it!

There's no better place to store your home-defense weapon within arm's reach than under your bed in the secure and easily accessible AMSEC Defense Vault!

The High Security electronic lock is easy to use, and in a matter of seconds, the door is open and the weapon is in hand!

Whether you currently have a safe or not, the Defense Vault should seriously be considered for any gun owner.

Features AMSEC's new ESL5 electronic lock with an illuminated keypad. Bright, backlit keys let you enter your PIN code, even in the dark.

The AMSEC Defense Vault is constructed of 14 ga. steel with a unique 5-point slide locking bar and features a foam-padded slide-out gun tray and 4 pre-cut anchor holes with mounting hardware.

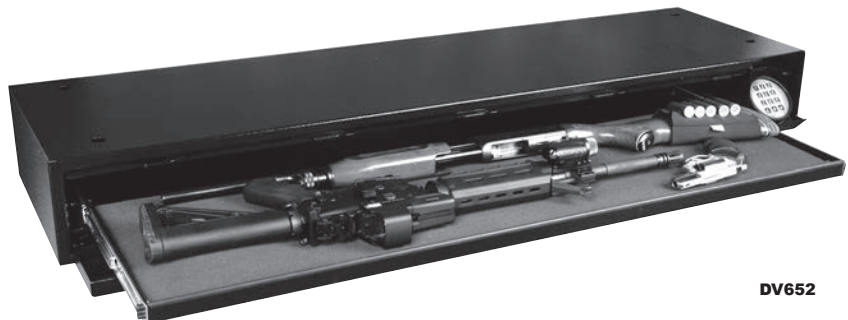

DV652

Model	Outside Dimension H x W x D	Wt. Lbs.
DV652	6" x 52" x 14"	74
Tray Size	3 3/8" x 43 1/4" x 13"	



CSC4520 EXECUTIVE
Shown with Optional S&G Electronic Lock

CSC4520 Executive Features:

- 4-5/8" thick door constructed with a 2" defense barrier of outer and inner steel plates creating a burglary resistant structure enclosing a unique proprietary, fire resistant composite material.
- 2-7/8" thick body enclosing a unique, high-density fire and burglary resistant composite material.
- Mercury Class IV fire protection of 1850°F for 2 hours, designed to maintain an interior temperature of less than 350°F.
- Heat expandable Palusol door seal guards contents against severe fires.
- Seven 1½" diameter solid steel locking bolts.
- U.L. Listed Group II combination lock with chrome-plated spy-proof dial and a tempered glass relock device. Optional electronic locks available.
- Heavy duty steel hinges.
- Attractively accented with a full width fascia, matching three point handle and logo.
- Durable and attractive charcoal gray textured finish.
- All-velour interior with 3 adjustable shelves, 1 fixed counter top and a 6 gun rack.
- Pre-punched electrical access hole equipped with a Gun Saver dehumidifier.
- Door mounted Stor-it Pack with multiple pouches for quick access to items
- One internal counter-sunk anchor hole and mounting hardware are provided to securely anchor safe.
- Removable casters provide easy delivery and installation.



Shown with Optional Clip-On Light Kit

Model	Exterior Dimension	Interior Dimension	Weight
CSC4520 EXEC	50.5h x 25.5w x 28.9d	45h x 20w x 21.2d	768

VAULT DOOR VD8030SF / VD8030BF



VD8030SF

Standard Features of The Vault Door:

- U.L. Listed Group II Lock with massive hard plate and two relocking devices.
- Spy-proof key-locking dial with matching five-spoke handle, pull handle and bold zinc die-cast logo. Available in polished brass, chrome or black nickel finish.
- 10 massive 1½" chrome-plated bolts. (Note: no deadbolts required on In-Swing door)
- Select from four textured finishes.
- Commercial grade, Vault Door hinges.
- 2 Stage Dual fire seals with silicone seal on door jamb and expandable Palusol™ seal on door.
- New - Adjustable door frame slides together to fit a wall thickness of 4-3/4" to 9-3/4".
- Safety Lock Release: allows you to safely exit the vault room from inside. It also allows you to close and lock the door from the inside when equipped with an electronic lock, turning your vault into a safe room.

Special Features of the VD8030SF & VD8036SF:

- 2" thick door offers a defense barrier constructed of a 1/8" inner and ¼" outer steel plates filled with a fire insulation material that provides a barrier against extreme heat.

Special Features of the VD8030BF & VD8036BF:

- 2" thick door offers a defense barrier constructed of a ½" steel plate door combined with 1-3/8" DryLight insulation that provides a barrier against extreme heat.

	Minimum opening required:	Door opening:	In-Swing Door opening:	Weight
VD8030SF	79½" H x 29½" W	77½" H x 26½" W	77½" H x 19 ¾" W	523 lbs.
VD8030BF	79½" H x 29½" W	77½" H x 26¼" W	77½" H x 19 ¾" W	695 lbs.
VD8036SF	79½" H x 35½" W	77½" H x 32½" W	77½" H x 25 ¾" W	612 lbs.
VD8036BF	79½" H x 35½" W	77½" H x 32¼" W	77½" H x 25 ¾" W	819 lbs.



AM SERIES HOME SECURITY SAFES



AM4020



AM2020

- Mocha fabric interior including back-cover and firewalls.
- Deep blue textured finish with bold, elegant American Security logo.
- Spy-proof dial and chrome "L" handle.
- Adjustable ball bearing hinges.
- High-strength unitized 12 ga. solid steel body.
- Massive 1 1/8" recessed door constructed of a 1/4" solid steel plate and a fire insulating material.
- 3-wheel combination lock protected by a drill-resistant hard plate. (U.L. Listed Group II Combination or Electronic lock available).
- 3-way boltwork with 5 active 1 1/4" diameter chrome-plated steel locking bolts (2020 Model has 4 active locking bolts).
- 4 pre-cut anchor holes with mounting hardware included.
- Fire protection of 1200°F for a period of 30 minutes. Designed to maintain an interior temperature of less than 350°F.
- Warranty: 1 Year Parts and Labor



Model	Outside H x W x D	Inside H x W x D	Cubic Inches	Thickness		Wt. Lbs.	Interior Shelves	Bolts
				Door	Body			
AM2020	20 x 20 x 20	17 x 18 1/4 x 14 1/2	4,710	1 1/2	12 ga	158	1	6
AM3020	30 x 20 x 20	27 x 18 1/4 x 14 1/2	7,402	1 1/2	12 ga	215	2	8
AM4020	40 x 20 x 20	37 x 18 1/4 x 14 1/2	10,094	1 1/2	12 ga	270	3	8

HANDGUN SECURITY

Handgun Safe PB2

Features:

- Deep blue powder coated finish with chrome hardware.
- Heavy-duty chrome handle.
- Strong, pry-resistant chrome locking bolt.
- Interior cushioned with foam lining to protect against scratches.
- Easy to change combination with programmable override code.
- 9V DC battery provides over 5,000 openings with low-battery indicator.
- External auxiliary battery connection.



Exterior Dimensions	Weight
8h x 12w x 4d	8 lbs

Drawer/Shelf Safe IRC412

Features:

Heavy duty steel construction offers excellent burglary protection. Convenient motorized locking system, incorporating the latest technology.

Easy to read, large LED display lets you know the status of the safe.

Reliable ADA approved keypad.

4 digit combination, standard hotel room configuration (customer sets new combination every time safe is used, quickly and easily), or electronic credit card.

Lock-out penalty if the combination is entered wrong, the safe will lock up for 5 minutes, frustrating the would-be burglar.

Emergency key-lock override system with 2 keys.

Fits in a drawer and only requires 5" clearance

Spacious interior fits most lap top computers.



Exterior Dimensions	Weight
4.5 h x 12 w x 14 d	15 lbs

TL-15 & TL-30 MONEY CHESTS

DXE / DXF AND CDXE / CDXF U.L. LISTED

AMSEC TL-15 and TL-30 U.L. Listed **MONEY CHESTS** qualify for Mercantile & Broadform Insurance Class ER (TL-15) and F (TL-30) with a banking rating of BR (TL-15) and G (TL-30). AMSEC MONEY CHESTS offer the highest level of security available with many outstanding features and a wide range of options.



CDXE2020
TL-30 Composite
Body and
Plate Door



DXE1818
TL-15 Plate Body
and Door

FEATURES

DOOR:

- DXE and CDXE models are TL-15 rated constructed of 3/4" thick solid steel plate.
- DXF and CDXF models are TL-30 constructed of 1 3/4" thick laminated steel with a special hardened drill resistant plate.
- Oil impregnated bronze bearing hinges.

BODY:

- DXE models: Consist of 1/2" thick steel plate (100,000 P.S.I. minimum tensile strength). All external seams are beveled and continuously welded.
- DXF models: Consist of 3/4" thick steel plate (75,000 P.S.I. minimum tensile strength). All external seams are beveled and continuously welded.
- CDXE and CDXF models: consist of 3/4" thick body constructed of inner and outer steel plates enclosing a high density composite material.
- Shelf strips installed allowing shelf adjustment. Shelves optional.

LOCKING MECHANISM:

- U.L. listed Group II key changeable combination lock, with relock and 1 million possible combinations.
- Single auxiliary spring loaded reloading device, activated by a punching attack.

- Locks and relocks protected by a large proprietary drill shattering composite hardplate.
- A handle activated locking mechanism consisting of two to five 1" chromed steel locking bolts.
- Five boltwork sizes allow AMSEC to build units from 12" (10 1/2" for DXE/DXF) to 88" high, widths from 14" to 41".
- Solid steel dead bar prevents door removal if hinges are removed during a forced entry attempt.
- Compact locking mechanism and boltwork cover allow for optional door mounted coin racks.

HINGES:

- Fabricated from high strength steel with precision machined alloy dowel pins.
- Oil impregnated bronze bearing assures easy opening doors and reduced maintenance.
- Vertical height adjustment.

FINISH:

- Available in Satin Black, Parchment, Standard Gray, Blue Gray, Romanesque Gray, Charcoal Gray, Granite, Sandstone or Chocolate Brown textured finish.

OPTIONS:

- Spyproof dial
- Key lock dial
- Coin racks
- Managers lockers
- Interior lockers
- Interior drawers
- Adjustable shelves
- Group 1 and 1R locks
- Electronic locks
- Access Control Systems
- Key-Op locks
- Dual combination locks (some models)
- 144 hour timelock
- 15 minute time delay lock
- External day lock
- Claddings
- Anchor bolt assembly
- Left swing door
- Internal rotary hopper
- Internal deposit slot
- Internal deposit chutes
- Hidden compartments
- Modular alarm
- Hold up duress alarm
- Special sizes
- Custom colors

For a detailed chart of sizes and specs for these models, please see the AMSEC Price List, Pages 12-13.

U.L. LISTED FIRE RATED MONEY CHEST



**ACF4024
SHOWN WITH
AUXILIARY LOCK**

AMSEC TL-15 and TL-30 U.L. Listed **MONEY CHESTS** qualify for Mercantile & Broadform Insurance Class ER (TL-15) and F (TL-30) with a banking rating of BR (TL-15) and G (TL-30). AMSEC MONEY CHESTS offer the highest level of security available with many outstanding features and a wide range of options.

FEATURES:

DOOR:

- 5½" thick door constructed of outer and inner steel plates enclosing a high density proprietary composite material.
- Two hour, 350°F factory fire rating. Tested at temperatures up to 1850°F.

BODY:

- 3¼" thick body constructed of inner and outer steel plates enclosing a high density proprietary composite material.
- Door and inner jamb surrounded by thick solid steel bars.
- Adjustable shelves.

LOCKING MECHANISM:

- U.L. listed Group II key changeable lock, with relock and 1 million possible combinations.
- Single auxiliary spring-loaded reloading device, activated by a punching attack.

- Locks and relocks protected by a large proprietary drill shattering composite hardplate.
- A handle activated locking mechanism consisting of three to five 1" diameter chromed steel locking bolts.
- Five boltwork sizes allow AMSEC to build units from 12" to 82" high, widths from 18" to 48" (interior dimensions).
- Bolt tensioner keeps locking bolts retracted in the open position.
- Handle designed to shear in case of forced entry attempt.
- Solid steel dead bars prevent door removal if hinges are removed during a forced entry attempt.
- Compact locking mechanism allows for optional door mounted coin racks.

HINGES:

- Ball bearing hinges fabricated from high strength steel.
- Precision machined alloy dowel pins.
- Oil impregnated bronze bearing assures easy opening doors and reduced maintenance.
- Vertical height adjustment.

FINISH:

- Available in Satin Black, Parchment, Standard Gray, Blue Gray, Romanesque Gray, Charcoal Gray, Granite, Sandstone or Chocolate Brown textured finish.

OPTIONS:

- Spyproof dial
- Key lock dial
- Coin racks
- Managers lockers
- Interior lockers
- Interior drawers
- Adjustable shelves
- Group 1 and 1R locks
- Electronic locks
- Access Control Systems
- Key-Op locks
- Dual combination locks (some models)
- 144 hour timelock
- 15 minute time delay lock
- External day lock
- Anchor bolt assembly
- Left swing door
- Internal rotary hopper
- Internal deposit slot
- Internal deposit chutes
- Hidden compartments
- Modular alarm
- Hold up duress alarm
- Special sizes
- Custom colors
- Custom designs



Model	Inside Dimension	Outside Dimension*	Clear Door	Cu. In.	Wt.	Shelves
ACF2020	20 x 20 x 20	26¼ x 26½ x 28¾	19 x 18¾	8,000	1,121	2
ACF2020XD	20 x 20 x 24	26¼ x 26½ x 32¾	19 x 18¾	9,600	1,235	2
ACF3020	30 X 20 X 20	36¼ x 26½ x 28¾	29 x 18¾	12,000	1,435	2
ACF3020XD	30 X 20 X 24	36¼ x 26½ x 32¾	29 x 18¾	14,400	1,572	2
ACF4024	40 X 24 X 20	46¼ x 30½ x 28¾	39 x 22¾	19,200	1,939	2
ACF4024XD	40 X 24 X 24	46¼ x 30½ x 32¾	39 x 22¾	23,040	2,105	2
ACF5024	50 X 24 X 20	56¼ x 30½ x 28¾	49 x 22¾	24,000	2,280	2
ACF5024XD	50 X 24 X 24	56¼ x 30½ x 32¾	49 x 22¾	28,800	2,468	2
ACF6030	60 X 30 X 20	66¼ x 36½ x 28¾	59 x 28¾	36,000	2,981	2
ACF6030XD	60 X 30 X 26	66¼ x 36½ x 34¾	59 x 28¾	46,800	3,320	2

* Add 2" to outside depth for handle, dial and hinge projection. Standard with two shelves. Optional 3-way boltwork available on the ACF line, retail price \$160.00. Custom size/design quoted upon request.

AMVAULTx6 TL-30x6 HIGH SECURITY SAFE



The new Amvaultx6 U.L. Listed TL-30x6, six-sided high security composite safes are made in the United States using the latest 2011 testing procedures set forth by Underwriters Laboratories.

The new revolutionary Amvaultx6 is constructed with a 3" defense barrier of inner and outer steel plates enclosing a unique interlocking heavy duty steel barrier, high strength concrete exceeding 12,000 PSI and a high-density high-strength ceramic matrix.

The high density insulating materials incorporated in the door and body also insure two hours of certified fire protection. The superior design and craftsmanship make the new Amvaultx6 impervious to burglary attacks attempted by the most sophisticated equipment utilized today and the vaults contents against intense fires.

Model	Inside Dim	Outside Dim*	Cu. Ft.	Door Opening	Wt.	Door Thickness (Overall)	Shelves
CFX252016	25 x 20 x 16	31 x 26 x 25¼	5	25 x 20	1,433	6"	1
CFX352020	35 x 20 x 20	41 x 26 x 29¼	8	35 x 20	1,946	6"	2
CFX452020	45 x 20 x 20	51 x 26 x 29¼	10	45 x 20	2,343	6"	3
CFX582820	58 x 28 x 20	64 x 34 x 29¼	19	58 x 28	3,418	6"	4
CFX703620	70 x 36 x 20	76 x 42 x 29¼	29	70 x 36	4,578	6"	4

U.L. LISTED FIRE RATED DEPOSITORY SAFE



ACF4824DS



AMSEC's ACF TL-30 **TWO DOOR DEPOSITORY SAFE** offers complete cash management versatility for any operation that requires a nonreturnable deposit such as armored car companies, convenience stores, restaurants, etc. The U.L. listed TL-30 composite construction offers peace of mind when overnight protection is required.

In addition to the outstanding features listed under ACF TL-30 Money Chest, the ACF4824DS Depository safe also offers:

TOP DEPOSIT / STORAGE COMPARTMENT

- Outer door equipped with a U.L. listed Group II combination lock and chrome plated front read dial.
- Large storage capacity: accommodates up to nine cash register trays.
- Large 3" x 18" deposit chute is protected by an "anti-fish", saw-tooth, hinged baffle.
- Two adjustable shelves.
- Door mounted four-opening rolled coin storage rack.

BOTTOM RECEIVING COMPARTMENT

- Outer door equipped with a U.L. listed Group II combination lock, chrome plated front read dial and an auxiliary key-op lock for dual control or armored car pick up.

Options:

- Electronic locks, Group 1 and 1R locks.
- Dual combination locks (Receiving compartment only).
- Spyproof dial, Keylock dial.
- Modular alarm, Holdup alarm.
- Interior lockers, Interior drawers, Adjustable shelves.
- Custom sizes/designs quoted upon request.
- Access Control Systems.

FINISH

- Available in Satin Black, Parchment, Standard Gray, Blue Gray, Romanesque Gray, Charcoal Gray, Granite, Sandstone or Chocolate Brown textured finish.

Model	Inside Dimension	Outside Dimension*	Clear Door	Cu. In.	Wt.
ACF4824DS	TOP 26 x 18 x 14 BOTTOM 14 x 18 x 17	47¾ x 24½ x 25¾	25 x 16¾ 13 x 16¾	6,552 4,284	1,746

* Add 2" to outside depth for handle, dial and hinge projection. Standard with two shelves. Optional 3-way boltwork available on the ACF line, retail price \$160.00. Custom size/design quoted upon request.



FIRE RATED COMPOSITE SAFES

During extreme testing procedures, **AMVAULT COMPOSITE SAFES** demonstrated the ability to withstand severe attacks by experienced U.L. experts using powerful tools such as sledgehammers, power saws, carbide disc cutters, drills, etc., and without fail, were awarded the U.L. TL-15 and TL-30 labels.

Besides withstanding the most concentrated attacks by sophisticated burglars, each AMVAULT safe offers a Two Hour, 350° F factory fire test certification, ensuring the protection of the vault's contents against intense fires.



CF6528
SHOWN WITH
OPTIONAL INTERIOR LOCKERS

1850°

AMVAULT
2-Hour,
350° F
rating
(Factory
tested at
1850°

1200°

Average
House Fire

450° F

Paper Chars

350° F

Interior of an AMSEC Safe



CF3524



**CE2518 WITH OPTIONAL
STOR-IT CABINET (PG 45)**

**OPTIONAL STOR-IT
CABINETS AVAILABLE
IN CE AND CF MODELS:
2518 / 3524 / 5524 / 6528 / 7236**

Fully upholstered safe interior kits available for these models.
See Page 45 for more details.

FEATURES:

DOOR:

- Overall thickness of 5¾" and is constructed with a 2¾" defense barrier of outer and inner steel plates creating a single structure enclosing a unique, high density fire and burglary resistant composite material.
- Defense barrier houses a proprietary amalgamation of nuggets and steel fibers to withstand concentrated attacks with the most sophisticated equipment used by burglars today.

BODY:

- The AmVault formed body has a total protective thickness of 3½" enclosing a high density fire resistant composite material with nuggets and steel fibers.
- A reinforced drill resistant door frame protects the door and each individual bolt chamber from severe side attacks.
- A proprietary inner barrier protects against peeling attacks.
- High strength adjustable shelves.

FIRE ENDURANCE:

- Two hour, 350°F factory fire rating. Tested at temperatures up to 1850°F

LOCKING MECHANISM:

- Equipped with six to ten massive 1½" diameter chrome plated solid steel locking bolts. Each bolt moves deep into the body's protected bolt chambers.
- Entire boltwork mechanism is also protected by a spring operated boltwork detent system. Bolts stay in the retracted position when the door is opened and automatically engage when the door is closed.

THREE-WAY BOLTWORK OPTION (TL-30 ONLY):

- Safes can be equipped with a three way active boltwork mechanism engaging the bolts horizontally and vertically into the body of the safe.

LOCKS:

- Equipped with a U.L. listed Group II key changeable combination lock. The lock is protected by a massive drill shattering hard plate and two additional spring-loaded devices.

HINGES:

- Offers a vertical height adjustment and utilizes an oil impregnated bearing ensuring easy door operation.

OPTIONAL AUXILIARY KEY LOCK:

- U.L. listed, high security auxiliary key lock is also available on all AMVAULT safes (except Model 1814). Lock is equipped with 2 keys and escutcheon plate.
- An additional spring-loaded relock device protecting lock against punch attacks.

OPTIONAL GLASS RELOCKING MECHANISM (TL-30 ONLY):

- Incorporated into the AMVAULT TL-30 auxiliary key lock is an optional high security tempered glass relock mechanism with a remotely and randomly placed "cross locking" relocking bolt and thermal cords to protect against torch attacks.
- In the event of an attack by tools, torches, or explosives, the glass will shatter activating the highly sophisticated relock mechanism.
- Utilizing the glass relock mechanism can offer up to a total of six different relock devices offering the ultimate in high security protection.

AMVAULT High Security Composite safes have passed Underwriter's Laboratories most recent testing procedures ensuring you today's best protection. AMVAULT TL-15 and TL-30 U.L. listed composite safes qualify for Mercantile & Broadform Insurance Class ER (TL-15) and F (TL-30) with a Bank Rating of BR (TL-15) and G (TL-30). Two Hour Class 350°F manufacturers' fire label. Standard finish is Parchment. Other colors available on request.



CUSTOM AMVAULT ESCUTCHEON PLATE
Shown with optional auxiliary key lock and pull handle, with matching operating handle.
*Tri-spoke handle standard on all models.

Model Number	Inside Dimension	Outside Dimension*	Cubic Feet	Weight	Interior Shelves	Door Swing		
	H x W x D	H x W x D				A	B	C
TL-15								
CE1814**	18 x 14 x 12	25 x 21 x 21½	1.8	710	1	14	36	39½
CE2518	25 x 18 x 16	32 x 25 x 25½	4.2	1,105	1	18	44	47½
CE3524	35 x 24 x 20	42 x 31 x 29½	9.7	1,674	2	24	56	57½
CE4524	45 x 24 x 20	52 x 31 x 29½	12.5	2,003	3	24	56	57½
CE5524	55 x 24 x 20	62 x 31 x 29½	15.3	2,343	3	24	56	57½
CE6528	65 x 28 x 20	72 x 35 x 29½	21.1	3,153	4	28	64	61½
CE7236	72 x 36 x 23	79 x 43 x 32½	34.5	3,880	4	36	80	72½
TL-30								
CF1814**	18 x 14 x 12	25 x 21 x 21½	1.8	725	1	14	36	39½
CF2518	25 x 18 x 16	32 x 25 x 25½	4.2	1,195	1	18	44	47½
CF3524	35 x 24 x 20	42 x 31 x 29½	9.7	1,908	2	24	56	57½
CF4524	45 x 24 x 20	52 x 31 x 29½	12.5	2,311	3	24	56	57½
CF5524	55 x 24 x 20	62 x 31 x 29½	15.3	2,679	3	24	56	57½
CF6528	65 x 28 x 20	72 x 35 x 29½	21.1	3,359	4	28	64	61½
CF7236	72 x 36 x 23	79 x 43 x 32½	34.5	4,426	4	36	80	72½

* Add 2" to outside depth for handle, dial and hinge projection.
**Models 1814 can not be equipped with an auxiliary lock, 3-way boltwork or glass relock mechanism. Left Swing Models: After model #, use suffix L.

DOOR SWING PROJECTIONS

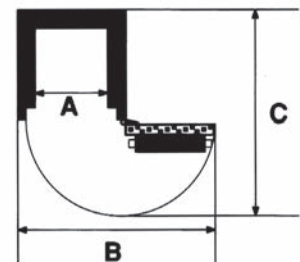

UNDERWRITERS LABORATORIES' BURGLARY RATING CLASSIFICATION

U.L. Label — Burglary Classification TL-15:

Signifies a combination-locked safe designed to offer a limited degree of protection against attack by common mechanical and electrical hand tools and any combination of these means.

Construction Requirements

- U.L. listed Group II, 1 or 1R combination lock.
- 750 lbs. minimum or comes with instructions for anchoring in a larger safe, concrete blocks or on the premises where used.
- Body walls of material equivalent to at least 1" open hearth steel with a minimum tensile strength of 50,000 P.S.I.
- Walls fastened in a manner equivalent to continuous ¼" penetration weld of open hearth steel with minimum tensile strength of 50,000 P.S.I.

- One hole ¼" or less, to accommodate electrical conductors arranged to have no direct view of the door or locking mechanism.

Performance Requirements

Successfully resist entry* for a net working time of 15 minutes when attacked with common hand tools, picking tools, mechanical or portable electric tools, grinding points, carbide drills and pressure applying devices or mechanisms.

U.L. Label —Burglary Classification TL-30:

Signifies a combination-locked safe designed to offer a moderate degree of protection against attack by common mechanical and electrical hand tools and any combination of these means.

Construction Requirements

Same as TL-15

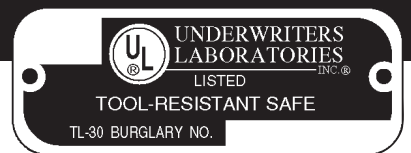

Performance Requirements

Successfully resist entry* for a net working time of 30 minutes when attacked with common hand tools, picking tools, mechanical or portable electric tools, grinding points, carbide drills and pressure applying devices or mechanisms, abrasive cutting wheels and power saws.

*Entry=Safes classed as TL-15 — opening the door or making a six square inch opening entirely through the door or front face. Safes classed as TL-30 — opening the door or making a six square inch opening entirely through the door or front face.

MECHANICAL LOCKS AND KEY LOCKS



AMSEC offers a wide variety of options not listed here. Consult your AMSEC price book or call for other available options. AMSEC's staff will also assist in helping you choose the correct options for your security needs.



U.L. Listed Group 2 Mechanical Combination Safe Lock Kit

Mechanical Combination Safe Locks have been around for over 100 years and are very secure and reliable. With the proper care and service, the AMSEC mechanical combination safe lock will last a long time.

Features:

- Three brass and aluminum combination wheels provide 1,000,000 theoretical combinations.
- Dual brass locking cams prevent wheel slippage.
- Solid brass locking bolt and zinc drop lever.
- Four-way brass drive cam allows mounting RH, LH, VU or VD.
- Internal spring-loaded brass relock trigger guards against punch attacks.
- Standard mounting footprint matches most mechanical and electronic safe locks.
- Large front-read convertible dial and ring.
- Both dial and ring are die cast with black finish and white letters.
- A solid, machined brass spindle – 4 7/8"
- Can be converted to a key-locking dial with a disc tumbler key cylinder and two keys (shown at right).
- Comes standard with an attractive self-stick solid dial insert or a key-locking dial insert.

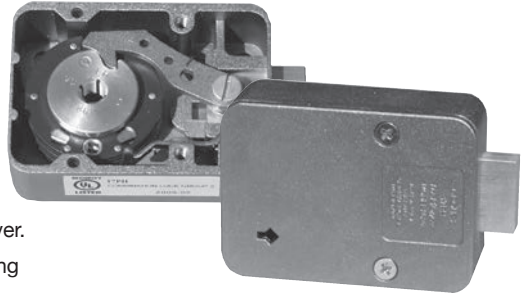

Safe Lock Kit Includes:

- U.L. Listed Group 2 mechanical safe lock.
- Large front-read convertible dial & ring, B/W finish.
- Non-key-locking dial insert.
- Key-locking dial insert.
- Key cylinder and two keys.
- Package mounting hardware and two spline keys.
- Combination change key.
- Durable packaging and foam inserts protect contents from shipping damage.



Spyproof Dial

Restricts unauthorized viewing while dialing combination. Also available with key locking feature.



Key Locking Front Read Dial

Key is used to lock dial in a fixed position and affords dual custody control. Manager has the combination, collector has the key. Both must be present to unlock the safe.



144 Hour Time Lock

Safes equipped with Time Locks offer the capability of locking the safe for a pre-selected period of time. Time periods range from one hour to 144 hours (6 full days).

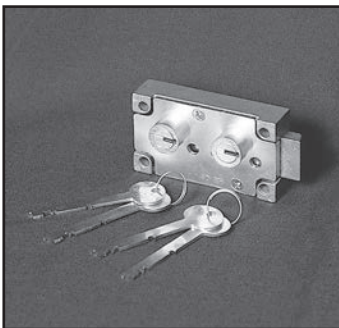

U.L. Listed Dual Nose Key Lock

Dual control safe deposit lock requires two different keys to open safe.

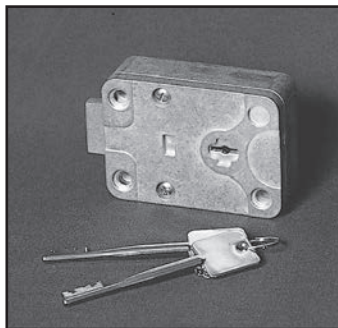

U.L. Listed Key Op Lock

European style seven-lever changeable key lock offers exceptional security features for use on inner locker or outer safe doors.

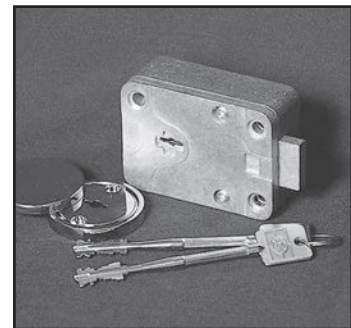

U.L. High Security Key Lock

European style nine-lever changeable key lock offers exceptional security features for use on inner locker or outer safe doors.



OPTIONAL EXTRAS

OPTIONAL EXTRAS



Interior Drawers

All drawers are commercial quality, heavy steel construction. Available in letter, legal and document sizes. Each is furnished with handle and key lock. All drawer capacities are 150 lbs. and come with a heavy duty latch removable ball bearing suspension.

Slotted Doors

Slotted doors are also available on freestanding plate safes, freestanding clad, composite chests, interior lockers and interior drawers.

Note: Safes with slotted doors are not recommended for overnight storage.

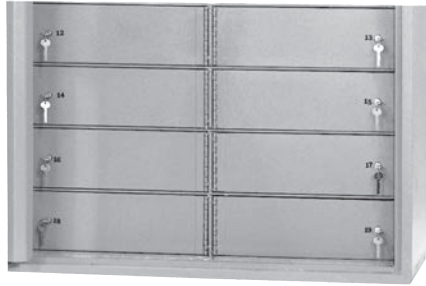

Interior Lockers

AMSEC offers a wide variety of standard interior locker compartments to fit your needs. Standard lockers are constructed of 10 gauge or 1/4" solid steel. Options include slotted doors, combination locks and high security key locks.

SUPER BRUTE "B" AND "CB" RATE SLOTTED SQUARE HINGED DOOR



STAR "C" RATE SLOTTED ROUND DOOR
with 3/8" x 3 1/2" slot



MINI BRUTE "B" RATE SLOTTED SQUARE LIFT-OUT DOOR

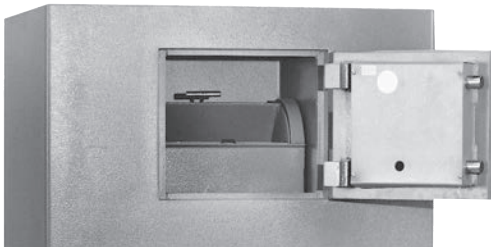

Interior/Exterior Hopper

Available in three different package sizes ranging from 5 3/4" D x 3 1/2" W x 8 3/4" L to 7" D x 4 1/2" W x 10 3/4" L.

Hoppers can be installed on the interior or exterior of plate, clad or composite safes.



Modular Alarm System

Detects vibration, heat and door openings. Heat indicator activates alarm when torch attack occurs. Internal magnetic door contact detects door opening. Internal vibration sensor activates alarm if safe is moved or during drill attack.

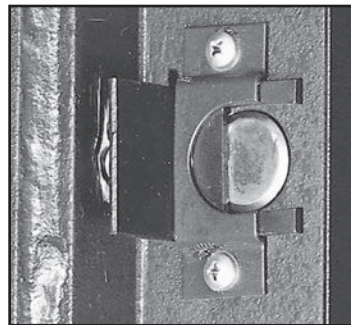

Locking Bolt Detent

Keeps locking bolts retracted when door is in open position. Prevents damage to safe body and boltwork mechanism caused by accidental door closure with bolts extended.

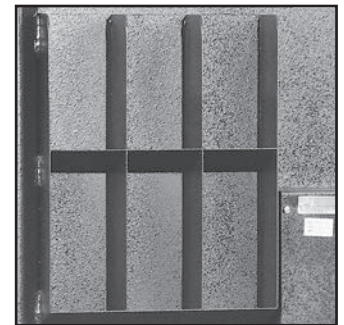

Coin Racks

For organized storage of coins. Mounted on inside safe door. Available with four or six compartments.



TELLER LOCKERS



FEATURES:

Body:

- 16"H x 32-5/8" W x 24" D, 1/4" solid steel construction.

Door:

- 1/4" solid steel, hinged from center, divider.

Hinge:

- Solid steel continuous hinge.

Color:

- Available in Satin Black, Parchment, Standard Gray, Blue Gray, Romanesque Gray, Charcoal Gray, Granite, Sandstone or Chocolate Brown textured finish.

Locks:

- U.L. listed double nose and single nose safe deposit locks or Medeco® camlocks standard. Combination locks optional extra.

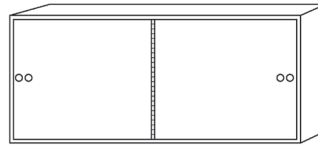

ATL-2
WEIGHT: 240 LBS.

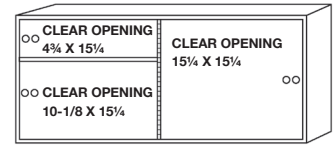

ATL-3R
WEIGHT: 255 LBS.

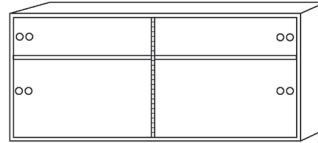

ATL-4
WEIGHT: 270 LBS.

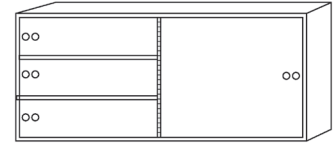

ATL-4R
WEIGHT: 270 LBS.

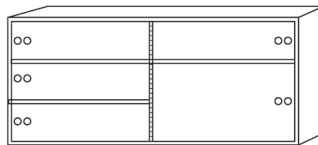

ATL-5R
WEIGHT: 285 LBS.

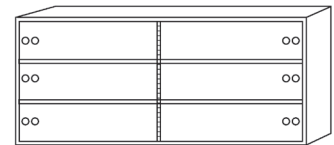

ATL-6
WEIGHT: 295 LBS.

CUSTOM SAFES

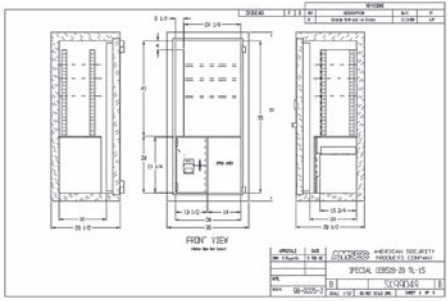

AMSEC specializes in manufacturing CUSTOM SAFES for supermarkets, banks, restaurants, convenience stores, gas stations, hotels, mini-marts and other businesses. With over 50 years experience building custom safes, AMSEC has the knowledge and expertise to design a safe to meet your cash handling requirements. Our engineering department is equipped with the latest in computer-aided design (CAD) systems for rapid creation of detailed sales sketches, concept drawings, final product prints and design modifications to help you visualize how the safe will look and function. Custom safes are available in every insurance classification from "B" Rate to U.L. listed TL-30 models.

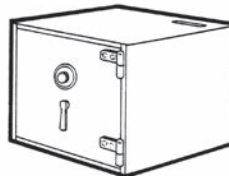
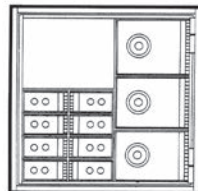
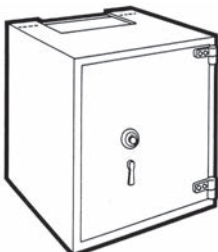
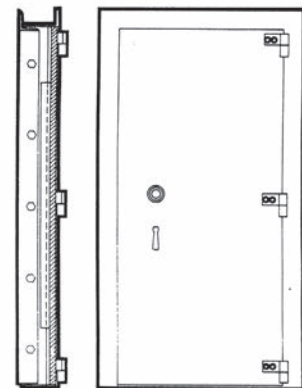
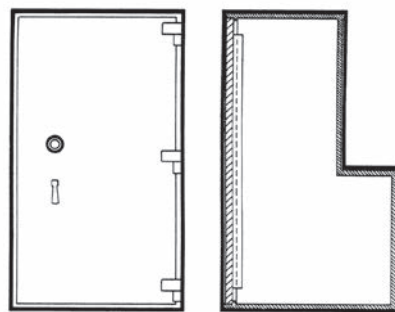
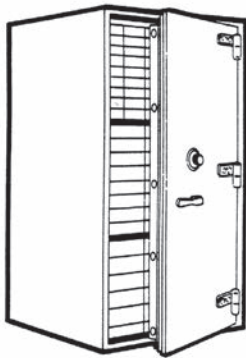



ELECTRONIC LOCK COMPARISON CHART

ELECTRONIC LOCKS



	SAFEWIZARD®				SMARTLING				AUDITCON		
	ESL-10XL	ESL-20XL	ESL-20XL	ESL-20XL	6120	6123	6126	6126	52	252	552
Housing	Round	Round	Round	Rectangle	Round	Round	Round	Rectangle	Round, Vehicle	Round, Vehicle	Round, Vehicle
Number of Users	1	8	2 Mgr 28 User	40	8	5	1 Programmer 3 Manager 6 Super User 20 User	Mgr. + (8)	2	20	99
Safe Doors	1	1	1	6 / 1 deposit	1	1	1	5	1	1	1
Power Source	(2) 9V/AC	(2) 9V/AC	(1) 9V	AC with Battery Back-up	(2) 9V	(2) 9V	(2) 9V	(1) 9V + (6) "C" (Opt.)	Self Generating/ Battery	Self Generating	Self Generating
Combination (number of digits)	6	6	6	Key +6 8 if keypad only Fingerprint +6 Card +6	6	8	8	6	6	8	8
Wrong Tty Lock Out (time)	YES	YES	4 (4 min.)	Settable	4 (15 min.)	4 (15 min.)	5 (10 min.)	YES	YES	YES	YES
Dual Mode	N/A	YES	YES	YES	NO	YES	YES	YES	YES	YES	YES
Time Delay	N/A	1-99 min.	Opt.	1-99 min.	1-9 min.	1-99 min.	1-99 min.	1-99 min.	YES (Order Model T-52)	YES	YES
Time Delay Open Input Window (time/by user)	N/A	1-9 min.	Opt.	1-99 min.	2 min./ fixed	2-9 min.	1-10 min.	1-19 min. factory set	NO	NO	NO
Time Lock (periods) *(Variable)	N/A	N/A	N/A	(6) (*)	N/A	N/A	N/A	(4) (*)	N/A	N/A	N/A
Duress	OPT	OPT	NO	STD	OPT	OPT	OPT	OPT	OPT	OPT	OPT
Audit Trail (# of events)	N/A	N/A	NO	YES 8000 w/ 500 Backup Time & Date	NO	NO	YES 600 Time & Date	YES (500)	NO	YES 100	YES 400 Time & Date
PC Software Audit Records	N/A	N/A	NO	(OPT)	NO	NO	(Opt) Audit Only	(OPT)	NO	YES (Opt) 100	YES (Opt) 400
Alarm Interface	N/A	YES (opt.)	NO	YES	NO	NO	YES	YES (Opt.)	NO	YES (Opt.)	YES (Opt.)
Bot Options Auto Lock	YES	YES	YES	YES	YES	YES	YES	YES	YES	YES	YES
Spring Bolt/ Slam Bolt	YES	YES	NO	YES	YES	YES	NO	YES (Opt.)	YES	YES	YES

AMSEC SAFEWIZARD®



The **SafeWizard®** electronic safe controller is a state-of-the-art electronic product for use in controlling and auditing access to safes. Designed to prevent burglaries and internal theft, the SafeWizard® controls and documents each access to the safe. Based on contemporary high speed processors, unique user friendly software techniques and ingenious application ideas, this system surpasses all other safe access control systems.

FEATURES:

- A powerful processor based on the ColdFire® 32 bit microprocessor.
- Flash Memory for quick and cost effective upgrades.
- Up to 10,000 audit entries and 40 users.
- Controls both outer and inner doors.
- Time Delay any door with a 1-99 minute delay and 1-99 minute open period with cancel feature.
- Time Lock any door, 1-6 windows per day.
- Authentication options: PIN code and/or Dallas Key access control, optional Finger Print Reader or Card Swipe devices are available.
- Wrong Try Count Penalty Lockout.
- Auto-Purge Idle Users option, selectable by Individual User.
- Forced PIN Changes to decrease risk of compromised PINs.
- Armored Car courier Time Delay and Lock Bypass.
- Duress/Hold-up Alarm with Silent Signal.
- Burglary Alarm output triggering from selectable events.
- Holiday Schedule with up to 16 programmable events per year.
- Automatic Daylight Savings Adjustment, selectable and configurable.
- Dual Control Mode on any individual door, selectable by user.
- Built-in key maker, complete with management tool set, audit trail sorting by several criteria.
- Deposit Tracking system to provide the highest level of cash management security.
- Communications possibilities are unrivaled. Incorporating Multiple Serial Devices, optional Ethernet Networking Port. Audits and administration can be managed through the Serial Port of Personal Computer or remotely via a Network connection.
- Audit utility allows PC based audit storage management, data filter and sorting capabilities and excellent exception reporting to focus on key security issues.
- Ultra-high contrast 8 line by 21 character graphics display.

- Rechargeable Battery Backup.
- Built-in System Diagnostics.
- Alarm Interfaces in the Power Supply Module interfaces the system to any conventional Alarm System, with simple connections for Alarm Output, Duress Output, CCTV Activation and an Input for Alarm System control of the SafeWizard system.
- Parallel Printer Interface.
- English, Spanish, French and German language options.



SafeWizard®

New WizAdmin Remote Communication Features

- With the optional Ethernet Networking Port (NMPS) and the WizAdmin remote safe access software, audits and administration can be accessed remotely via a network connection.
- Remote operators are assigned a USB security key and predetermined user authority level (UAL) facilitating administration at any desired level.
- Enroll unlimited safes in any time zone and maintain a full configuration record.
- Safe Audits: Provide date, time, event and user filtering capability.
- Safe User: Administer individual user profile list as well as modify, add or delete functions.
- Safe Locks/Doors: Administer all access control perimeters.
- Exception Event: Provides e-mail notifications of selected safe activity.
- Group Administration: Group multiple safes to a region or city and allows group administration changes to be applied as a single action.
- Print Summary Report: Provides a list of enrolled safes and basic information.
- Print Safe Detail: Provides detailed safe configuration report with time delay, time lock, holiday schedules, etc.
- Reboot Controller: Allows a remote system reset.
- Other Remote Administration Functions: Set safe clock, time delay settings, duress, pin reject mode, repeating holidays and much more!

THE AMSEC SAFEWIZARD ELECTRONIC ACCESS CONTROL SYSTEM IS AVAILABLE ON NEW AMSEC SAFES OR AS RETROFIT KITS.

Authentication Options:

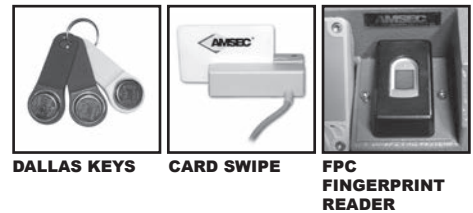

DALLAS KEYS

CARD SWIPE

FPC FINGERPRINT READER

Accessories:

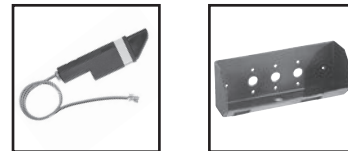

DOOR SENSOR
Monitors door position (standard on external doors)

SAFEGUARD
Protects controller against accidental damage

AMSEC ESL20x2



The New **ESL20x2 Electronic Lock** offers unrivaled value in electronic safe access. The ESL20x2 offers all the impressive features of the ESL20XL series lock and blends it into a two lock system with a convenient external slanted

keypad. The new ESL20x2 offers advanced features necessary for commercial applications. **See more about the standard features of the ESL20 lock on page41**

New ESL20x2 Features:

- New alpha-numeric slanted keypad operates two locks.
- Choose Lock 1 or Lock 2 input keys to activate each lock.
- Ultra-Bright green LED light signals which lock is selected.

- Ultra-Bright red LED light signals the status of each lock (Keystroke, Penalty lockout, Bad combo entry or Time Delay).
- An Internal deposit locker equipped with conventional keypad can be difficult to use. The new ESL20x2 eliminates the need to bend down to operate the safe and the new Ultra bright LED's and enhanced sound enunciator make it easier to use from a distance.
- Ultra-Bright red A/C Power LED light indicates A/C power is on. Use two 9v batteries as back up.



AMSEC ESL-XL SERIES

ELECTRONIC LOCKS



ESL10XL FEATURES:

ESL10XL WITH BRASS FINISH

- Replaces most mechanical combination locks. Easy installation and operation.
- Factory Reset Combination for solving lost combinations without requiring expensive service calls.
- Electronics are encapsulated within the lock and are sealed to prevent possible moisture related failures.
- Cable fits through a 1/2" spindle hole without cutting and re-crimping connector.
- Audible beep and flash from every keystroke gives maximum feedback to the user.
- 15 minute Penalty Lockout after four incorrect entries protects against manipulation attempts.
- New patented dead-latched lock design with an internal relock device for maximum security.
- Lock "auto-locks" when boltwork is thrown to prevent safes from being left in a day lock position.
- Slam Bolt version for locker applications.
- Optional internal battery pack extends operation between battery changes.

ESL20XL

ADDITIONAL FEATURES:

- Time Delay Mode: Delays can be set from 1 to 99 minutes.
- Multiple User Mode: When enabled, one Master code and eight user codes are available with full supervisory control and code management.
- Dual Control Mode: The lock can be programmed to require two combinations to open for added security.
- Armored Car Override: When enabled, allows an armored car service to bypass Time Delay.
- External A/C Power: Provides power for unlimited use with battery power as backup.
- Control Port: Turn the ESL20XL on/off with an Alarm System or other device.

Optional Expansion Modules:

Provides these additional capabilities on the ESL20XL:

- Duress (Silent Signal) Alarm Output. Provides relay output for alarm system connection.
- External connection for A/C power transformer on ESL20XL and ESL10XL.
- External connection for control port.
- Provides for connection of one or two ESL20XL locks.



ESL20XL WITH BLACK FINISH

All the ESL20XL features are programmed from the keypad. The Expansion Modules provide convenient screw terminal and slip spade connections for field wiring by the installer.

A/C Power can be connected to the ESL10XL and ESL20XL lock (with the ESLAC kit) or an Expansion Module (with the ESLTFMR kit). Wiring, conduit and attachment hardware is provided with all optional kits.

Model	Description	Finish
ESL10XL	ESL10XL Standard Lock	Black Nickel, Chrome, Brass
ESL10XL-S	ESL10XL Slam Bolt Lock	Black Nickel, Chrome, Brass
ESL20XL	ESL20XL Standard Lock	Black
ESL20XL-S	ESL20XL Slam Bolt Lock	Black

* Lock factory installed in place of the standard Mechanical Combination Lock, Dial and Dial Ring.
 ** Lock factory installed as an auxiliary lock, includes all mount pads and hardware for installation. Please refer to our Retail Price List for a complete list of part numbers for primary lock, auxiliary lock and Retrofit kit options.

Accessory Number	Description
ESLBAT	Aux. Battery pack for any ESL Locks. Provides extended life on battery power.
ESL20XLEXP1	Expansion Kit for (1) ESL20XL lock. External box with duress capability.
ESL20XLEXP2	Expansion Kit for (2) ESL20XL locks. External box with duress capability.
ESLAC	A/C Power kit for use with any ESL lock. Provided with conduit and fasteners.
ESLTFMR	A/C Transformer for use with any Expansion Kit.

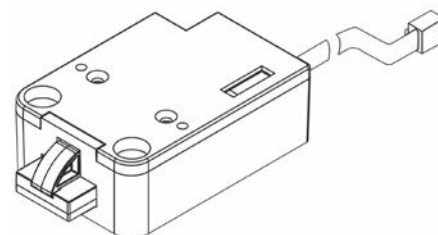

SLAM BOLT

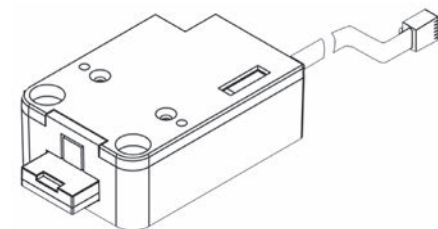

STANDARD BOLT

AMSEC BIOMETRIC ELECTRONIC LOCK



Biometric Lock

AMSEC's NEW **Biometric Series Electronic Lock** incorporates patented fingerprint technologies to offer customers a high end system for safe applications. It features a unique Self-Learning software function, user-friendly LCD info display, programmable Time Delay / Time Window, and 30 fingerprint user capacity. The Biometric Series Electronic Lock provides a complete control system to safeguard your valuables.

Features:

- U.L. Type 1 listed.
- Patented OneTouch™ auto fingerprint verification
- Unique Self-Learning function
- Battery saving design with one 9V battery operation and low battery alert
- Multiple Users
- Programmable Time Delay 0-99 min.
- Wrong password lock out
- User-friendly LCD Display
- Brass or Chrome Finish

SARGENT AND GREENLEAF COMPTRONIC™



SARGENT AND GREENLEAF
A lock on security.



S&G 6120
E-Z KEYPAD

S&G 6120
ROUND KEYPAD

Standard features on all COMPTRONIC™ Electronic Safe Locks:

- All Combination changes and programming are easily made at keypad.
- Uses two (2), 9V Alkaline batteries -Duracell® recommended. (E-Z keypad uses (1) 9V battery.)
- Keypad feedback with beep and LED flash.
- Multiple users.
- Programmable Time Delay.
- Motor driven bolt.
- Wrong combination try penalty.
- U.L. Type 1 listed.

COMPTRONIC™ Keypad Finishes:

- Chrome - satin or bright.
- Brass - satin or bright.
- Black - matte only
- Gold - 14K or 24K

Optional Security Enhancement Accessories:

- Spy-Proof® Cover.
- Time Delay Status Indicator.
- Bolt Position Indicator.
- Duress and Remote Activation Modules.
- Audit Trail (Model 6124/25 only).

For detailed specifications, visit www.sglocks.com

KABA-MAS AUDITCON® 2

Featuring PowerStar Technology:

Use of an internal generator creates all the necessary power. No batteries or external power is required.



AUDITCON®
ROUND PROFILE

For detailed specifications, visit www.kaba-mas.com

Model 52 Series:

- Stand-alone, single combination access control.
- Dual Mode (2-user) function that provides a small business or individual with the convenience of electronic locking.
- Model T52 meets all specifications of the Model 52, plus is fitted with a time delay feature.

Model 252 Series:

- Offers advantages of basic electronic locking.
- Programmable keypad with resettable combinations.

- Time Delay.
- Multi-user access control with audit capability.
- Audit Software Extra.

Model 552 Series:

- Easily replace traditional mechanical Group I and Group II locks.
- Upgrades the security of any safe or archive storage unit.
- Perfect for security applications where shared access and audit capability are necessary.
- Audit Software Extra.



LAGARD ELECTRONIC SAFE LOCKS

ELECTRONIC LOCKS

LAGARD



LG BASIC II

LG BASIC II Electronic Lock

Standard Features:

- Manager Mode.
- Wrong Try Penalty.
- Outside Battery Compartment (Located under input housing).
- Uses one (1) user-supplied 9V Alkaline Battery.
- Satin-Chrome Angular Input Housing (Brass Optional).
- U.L. Listed.
- Made in USA.

Part # 3715 Angular Round Entry
Part # 3765 Dual-Handed Swing-Bolt

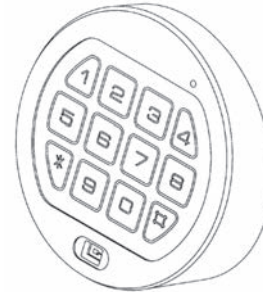

LG BASIC ANGULAR
ROUND ENTRY
(PART #3715)

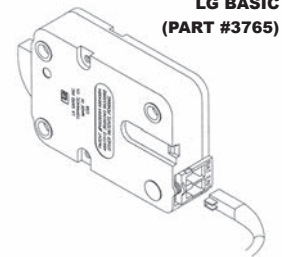

DUAL-HANDED
SWINGBOLT LOCK
LG BASIC
(PART #3765)

SAFEGUARD Digital Combination Lock

Standard Features:

- Direct Replacement - Most Mechanical Combination Locks.
- Wrong Try Penalty.
- Optional Features: Programmable at any time by Authorized Service.
- Uses user-supplied 9V Alkaline Batteries.
- U.L. Listed.
- Made in USA.

Programmable Features:
(with Optional Hand-Held Programmer)

- Second user.
 - Delay Period: 1-99 minutes
 - Open Period: 1-19 minutes
- Time Delay
- Time Delay override.
- Dual Combination.
- Silent Signal Alarm
 - Optional box required
- Remote Override Signal
 - Optional Alarm box required

Part # 4100 Swingbolt Lock



SAFEGUARD



SMARTLINC

SMARTLINC Serial Access Control

Standard Features:

- Wrong Try Penalty.
- Signal to Disable Lock.
 - Optional Alarm/Battery Box required
- System Status shown on LCD or optional printer.
- Audit trail by way of optional software.
- Optional battery box contains six user-supplied C-Cell Alkaline Batteries.
- U.L. Listed.
- Made in USA.

Programmable Features:

- Manager Mode.
- Multiple users.
- Dual Combination.
- Time Delay
 - Delay Period: 1-99 minutes
 - Open Period: 1-19 minutes
- Time Delay override. (#9 osev).
- Silent Signal Alarm
 - Optional box required
- Time Lock set, 4 standard lock periods per day. (Special events takes precedence over Standard Week).
- Languages: Manager LCD display in English, Spanish, French, German or Italian.

For detailed specifications on LaGard locks, visit www.lagard.com

MATERIALS HANDLING EQUIPMENT



Provide a higher level of service to your customer with AMSEC's new line of **MOVING EQUIPMENT**, giving you the capability to deliver and install any size safe -- quickly and safely!



LIFT 'N' ROLL MODEL 1500NR

Lift 'N' Roll

- Load is always stable and balanced.
- The hydraulic rams allow easy raising and gentle lowering of load from 1/8" to 4 1/2".
- Non-marking polyurethane wheels and padding system.
- Two handles on each side provide ease of maneuvering.
- Lightweight design. Built to last.
- Sturdy steel construction.
- Capacities up to 1,500 lbs.

UltraLift Powered Hand Truck

Designed to meet your on-the-job requirements, the UltraLift is the best move you will ever make. Machine weight includes strap bar, 4-wheel dolly and spill-proof gel cell battery. Minimum overall machine height is with extension handle retracted for moves in restricted areas. Maximum height is with handle fully extended for maximum leverage:

- Great versatility: Handle any load on the level, up and down the stairs, on and off trucks, over obstacles and many more.
- Light-weight aluminum stands up to years of rough use.

- The operator stays in control by using a combination of motor power, balance and leverage.
- One person can easily handle every load, even up and down the stairs, reducing labor costs.
- Gentle handling eliminates bumps and bounces to loads and premises, eliminating damages.
- Pay-off is approximately 21 installs (based on a national average of \$200 per install).
- Load capacity up to 1,500 lbs. Machine weight is 120 lbs.
- Optional accessories available. See AMSEC's Retail Price Book.



ULTRALIFT MODEL 1500UL



Triple L Trailer

The design of this patented, innovative trailer is the result of Premco's extensive engineering and testing procedures. Triple L Trailers offer the highest quality and best value of any trailer on the market!

L Trailers offer the highest quality and best value of any trailer on the market!

Features:

- Heavy duty tubular chassis - steel diamond deck plate supported by 4 tubular members running the full length of the deck to give complete wheel support for heavy loads.

- Level loading - deck remains level throughout raising and lowering.
- Full width rear ramp angle allows easier loading.
- Hydraulic System activated by a single lever.
- Oversized deck bearings rated for 80,000 lbs. - each bearing greaseless and sealed.
- Automatic latch locks upon raising for added travel security.
- Battery, pump and motor are enclosed in a lockable compartment.

- Lockable tool box - ideal for storing chain binders, tie down straps, etc.
- Heavy duty adjusting tongue jack.
- Lights Standard.
- Charcoal powder coated finish.
- 1 Year Manufacturers Warranty.

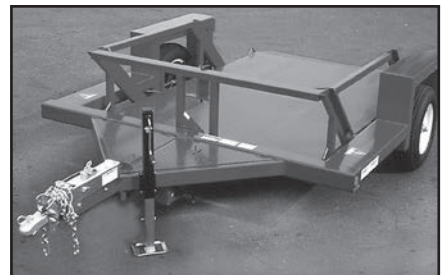

MODEL 4610

Model	248	4610	7610
Capacity	2200	4500	7000
Deck Size	4' x 8'	6' x 10'	6' x 10'
Overall Width	80"	101"	101"
Lift Mechanism	Winch	Hydraulic	Hydraulic
Axle	Single	Single	Tandem
Suspension	Torsion	Spring	Spring
Wheel Size	15"	14.5"	15"
Brakes	No	Electrical	Electrical
Hitch (Ball Size)	2"	2"	2-5/16"
Weight	1,510 lbs.	2,070 lbs.	2,500 lbs.

* Specification and design are subject to improvement and may change at any time without notice.



LOAD



LIFT



STOR-IT CABINETS

STORAGE OPTIONS

Stor-it-Cabinets

These elegant, well-appointed **2-DRAWER AND 4-DRAWER INTERIOR CHESTS** are finely crafted in solid-wood maple drawer fronts and maple veneer and finished in a rich honey maple stain.

NEW recessed door pulls give these cabinets a more streamlined appearance and makes for an easier fit into a variety of AMSEC safes. All drawers are elegantly lined in a silky, dark red felt with heavy-duty, ball-bearing drawer glides and include a variety of Stor-It Jewelry Organizer Inserts. Each insert can be removed for easy viewing, selecting and protection of your jewelry.

2-DRAWER OPTION:

- Top drawer includes a Three Compartment Ring Organizer and a Seven Compartment Jewelry Organizer. Bottom drawer can be used for bulky items or converts to a file drawer.
- Outside Dimensions: 16³/₄" x 16" x 14¹/₈"
- Weight: 28 lbs.



4-DRAWER OPTION:

- Top drawer features a three compartment ring organizer and a seven compartment jewelry organizer. Drawer two features a three compartment necklace organizer. Drawer three features a four compartment watch organizer. Drawer four can be used for bulky items, or add more Stor-it Jewelry Organizers.
- Outside Dimensions: 16³/₄" x 16" x 14¹/₈"
- Weight: 29 lbs.

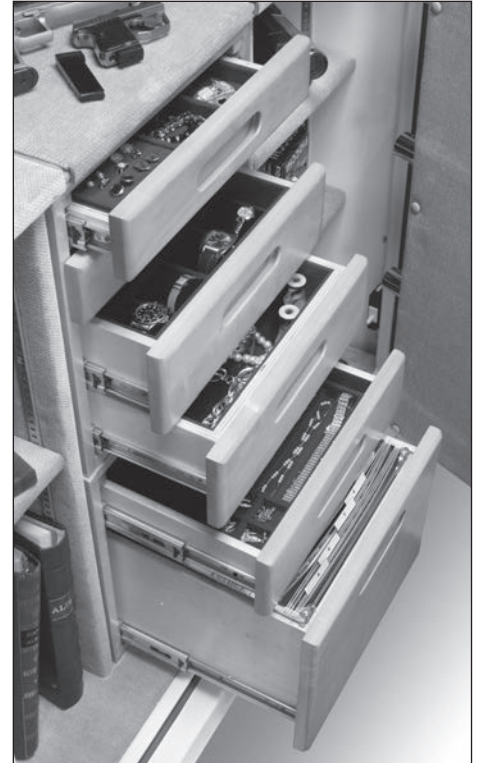

STOR-IT CABINETS ARE AVAILABLE IN THE FOLOWING SAFE MODELS:

GUN SAFES: RF6528, HS7943, HS6743, BF7250*, BF7240, BF6636, BF6030, SF6036 and SF6030

BURGLARY/FIRE SAFES: BF1716* / BF3416*

CE AND CF MODELS: 2518* / 3524* / 5524* / 6528* / 7236*

CSC MODELS: CSC3018* AND CSC4520*

* No kit needed. Drawers slide right in.



STOR-IT JEWELRY INSERTS

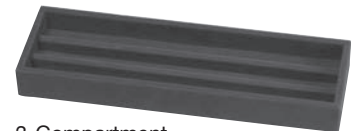

3-Compartment
Necklace Organizer

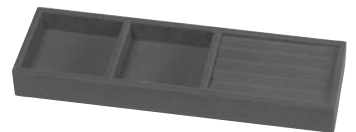

3-Compartment
Ring Organizer

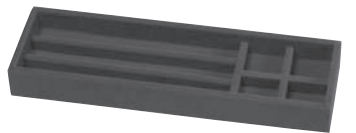

7-Compartment
Jewelry Organizer

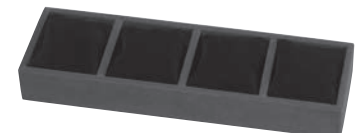

4-Compartment
Watch Organizer



MERCHANDISING / DISPLAYS

PART #	DESCRIPTION
1045008	3-PACK SAFES: WS1014, WEST149, & WS1214 Also includes display stand, POP, product tags, color poster and consumer brochures
1045020	4-PACK PROMOTIONAL KIT: safe pedestal, sales banner, 3 hanging signs, safe usage poster, window decal, consumer brochures, product tags, & authorized dealer certificate.
1045021	8-PACK PROMOTIONAL KIT: Large illuminated clock, two safe pedestals, sales banner, 4 hanging signs, safe usage poster, window decal, consumer brochures, product tags, & authorized dealer certificate.
1045169	10-PACK PROMOTIONAL KIT: Includes the 10 safes listed below, and an AMSEC POP Display rack. Safes (2 of ea. / 1 to show, 1 to go): EST916, EST1014, EST813 compact burglary safes and the new EST914, EST1814 U.L. Listed 1 hour fire safes. Retail value \$2820.00 Also receive consumer brochures and 6 magnetic tags



ELECTRONIC SAFE DISPLAY RACK
PART #1045161

3-PACK DISPLAY
PART #1045007

DISPLAY PEDESTAL
PART #1045014

AMSEC INDIVIDUAL SALES AIDS

PART #	DESCRIPTION
1045022	Illuminated Clock (15" x 30")
1045014	Display Pedestal
1045161	AMSEC Electronic Safe Point of Purchase Display Rack
1045000	Sales Banner (5ft w x 3ft h)
1045004	Magnetic Price Tags (4 x 6) - Pack of 6
1045024	"Burglary/Fire Safes" Hanging Sign (21"w x 10"h)
1045028	"Fire Safes" Hanging Sign (21"w x 10"h)
1045029	"Floor Safes" Hanging Sign (21"w x 10"h)
1045030	"Depository Safes" Hanging Sign (21"w x 10"h)
1045134	"Wall Safes" Hanging Sign (21" w x 10"h)
1045133	"Gun Safes" Hanging Sign (21" w x 10"h)
1015241	Authorized Dealer Window Decal
1045073	Guide to Safe Usage Poster (24"w x 18"h)
4305127	Retail Price List
4305128	Guide to All Products Brochure (color 4 x 9)
1045129	Dealer Catalog (8½ x 11)
4305172	Gun Safe Brochure
4305222	Gun Safe Mini-Brochure
4305263	Vault Door Trifold / Self-Mailer
4305225	Wall Safe Trifold / Self-Mailer
4305238	Storage Cabinets Trifold / Self-Mailer
1045157	Vault Door Promo POP Standup
1045072	Gun Safe Warranty Poster
1045076	BF® Gun Safe Authorized Dealer Banner
1045058	BF® Door Cutaway Plaque
1045071	BF® Body Cutaway Plaque
1045070	AMSEC Color Panel Display
4305174	Warranty/Operating Booklet
1045007	3 pack display only



BF® SAFE BODY CUTAWAY
PART #1045071

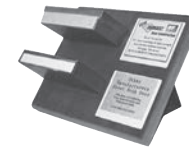

BF® SAFE DOOR CUTAWAY
PART #1045058



SALES BANNER
5FT W X 3FT H
PART #1045000



MAGNETIC PRICE TAGS (PACK OF 6)
PART #1045004

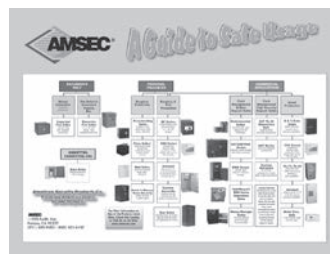

SAFE USAGE POSTER
(24"W X 18"H)
PART #1045073



VAULT DOOR PROMO STANDUP
PART #1045157



GUN SAFE CATALOG
PART #4305172



PRODUCT CATALOG
PART #4305129



RETAIL PRICE LIST
PART #4305126



ALL PRODUCT BROCHURE
PART #4305128



GUN SAFE "MINI" BROCHURE
PART #4305222



"BURGLARY / FIRE SAFES" HANGING SIGN (21" W X 10" H)
PART #1045024



INDEX BY MODEL NUMBER

INDEX BY MODEL NUMBER

A

ACF2020..... 32
 ACF2020XD 32
 ACF3020..... 32
 ACF3020XD 32
 ACF4024..... 32
 ACF4024XD 32
 ACF4824DS 33
 ACF5024..... 32
 ACF5024XD 32
 ACF6030..... 32
 ACF6030XD 32
 AM2020 30
 AM3020 30
 AM4020 30
 AUDITCON® 42

B

B6..... 7
 B17..... 7
 B24..... 7
 B400..... 5
 B700..... 5
 B1500..... 5
 B1806..... 5
 B1810..... 5
 B1816..... 5
 B1816D..... 5
 B2200..... 5
 B2900..... 5
 B3700..... 5
 B3800..... 5
 B5800..... 5
 BD24..... 7
 BDP24 7
 BF1512..... 18
 BF1716..... 18
 BF2116..... 18
 BF3416..... 18
 BF6030..... 24
 BF6032..... 24
 BF6636..... 24
 BF7240..... 24
 BF7250..... 24
 Biometric Lock..... 42
 BLB2018..... 16
 BLB3018..... 16
 BLB3024..... 16
 BLB4024..... 16
 BLC2018 16
 BLC3018 16
 BLC3024 16
 BLC4024 16
 BSW2020..... 11
 BSW2025..... 11

BSW3020..... 11
 BSW3025..... 11
 BSW4020..... 11
 BSW4025..... 11
 BWB2020..... 12
 BWB2020..... 15
 BWB2025..... 12
 BWB3020..... 12
 BWB3020..... 15
 BWB3025..... 12
 BWB3025..... 15
 BWB4020..... 12
 BWB4020..... 15
 BWB4025..... 12
 BWB4025..... 15

C

C3..... 6
 C5..... 6
 C7..... 6
 CB23 21
 CD5 6
 CD7 6
 CDXE 31
 CDXF 31
 CE1814..... 35
 CE2518..... 35
 CE3524..... 35
 CE4524..... 35
 CE5524..... 35
 CE6528..... 35
 CE7236..... 35
 CF1814..... 35
 CF2518..... 35
 CF3524..... 35
 CF4524..... 35
 CF5524..... 35
 CF6528..... 35
 CF7236..... 35
 CFX252016..... 33
 CFX352020..... 33
 CFX452020..... 33
 CFX582820..... 33
 CFX703620..... 33
 CSC1413 19
 CSC1913 19
 CSC3018 19
 CSC4520 19
 CSC4520 EXEC 29

D

DSC2014KC..... 13
 DSF2014..... 13
 DSF2714..... 13
 DSF2731..... 13

DSF3214..... 13
 DSR2014 13
 DSR2714 13
 DST2014..... 13
 DST2714..... 13
 DST2731..... 13
 DST3214..... 13
 DV652..... 28
 DXE..... 31
 DXF..... 31

E

ESF1214..... 22
 ESF1214..... 22
 ESL10XL..... 41
 ESL20XL..... 41
 EST149..... 20
 EST712..... 20
 EST813..... 21
 EST914..... 20
 EST916..... 21
 EST1014..... 21
 EST1814..... 20
 EST2014..... 21

F

FS149..... 20
 FS914..... 20
 FS2215..... 20

H

HS6743..... 23
 HS7943..... 23

I

IRC412..... 30
 IRC916E..... 22

K

K-1 / K2 9
 KB93..... 21

L

LG BASIC II 43

M

MM2820EE..... 14
 MS1414 15

P

PB2..... 30

R

RF6528..... 23
 RMM2620SW-L..... 10
 RMM2620SW-R..... 10
 RMM2620X2-L..... 10
 RMM2620X2-R..... 10

S

SAFEGARD..... 43
 SafeWizard® 40
 SF5924..... 25
 SF6030..... 25
 SF6032..... 25
 SF6036..... 25
 S&G 6120..... 42
 SMARTLINC..... 43

T

T425..... 7
 T625..... 7
 T625DD 7
 T925..... 7
 T925DD 7
 TB0610..... 9
 TF5517..... 26
 TF5924..... 26
 TF6030..... 26
 TF6032..... 26
 TF6036..... 26
 TF7240..... 26

U

UL1511..... 17
 UL1812..... 17
 UL1812X..... 17
 UL2018..... 17
 UL2818..... 17
 UL3918..... 17

V

VD8030BF 29
 VD8030SF 29
 VD8036BF 29
 VD8036SF 29

W

WEST149..... 8
 WEST2114..... 8
 WFS149 8
 WS1014 8
 WS1214 8
 WS1514K 8

**TEXTURED
COLORS**



PARCHMENT



**ROMANESQUE
GRAY**



GRAY

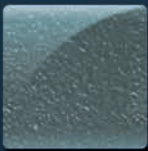

**BLUE
GRAY**



**SATIN
BLACK**



**CHARCOAL
GRAY**

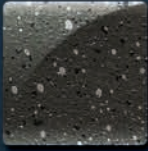

GRANITE



SANDSTONE



**CHOCOLATE
BROWN**



**AMSEC is the world's leading
producer of burglar resistant safes.
Here's why:**

Volume

We produce over 60,000 safes each year! Whether you need one safe or one hundred, we can design and build a safe that meets your specifications and requirements.

Manufacturing

We are located in Fontana, California is just ten minutes from Ontario International Airport. In 1998, we expanded our factory to 150,000 sq. ft. to better serve your needs.

Employees

AMSEC employs a force of 400 to ensure timely design, manufacturing and delivery of quality safes.

Underwriters Laboratories Ratings

Our products lead the industry with multiple U.L. Listings in various categories.

Round-the-clock- Customer Service

Our customer service representatives are available to help 24 hours a day, 365 days a year. Just call our toll-free hotline.

**HIGH GLOSS
COLORS**



**PLATINUM
METALLIC**



**MACADAMIA
METALLIC**



**BURGUNDY
METALLIC**



**HUNTER GREEN
METALLIC**



**CHARCOAL
METALLIC**



ONYX



PEARL

American Security Products Company

11925 Pacific Ave., Fontana, CA 92337
Phone: 951-685-9680 • Toll Free: 800-421-6142
Fax: 951-685-9685
Email: contacts@amsecusa.com
www.amsecusa.com

TWO-TONE COLORS

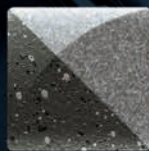

**GRANITE /
CHARCOAL METALLIC**



BLACK / ONYX